

Corporate Summary For Investors

As of Nov.7, 2024

Securities code:4202

Introduction



**Using “technology for melting wood”
to build a circular society that
balances ecology and economy**

Y. Ogawa

Yoshimi Ogawa
President and CEO
Daicel Corporation

Table of Contents

Introduction	2
Basic Philosophy/Management Policy	3
Daicel efforts to create a bright future	4
About Daicel	5
Daicel's Strengths	6
Daicel Group by Product Lines and Technical Field	7
Daicel Group Business	8
Long-Term Vision and Mid-Term Management Strategy	14
Shareholder Returns	26
Corporate Overview	27
Appendix	28

The company making lives better by co-creating value

Sustainable Value Together



Daicel Group Philosophy Structure

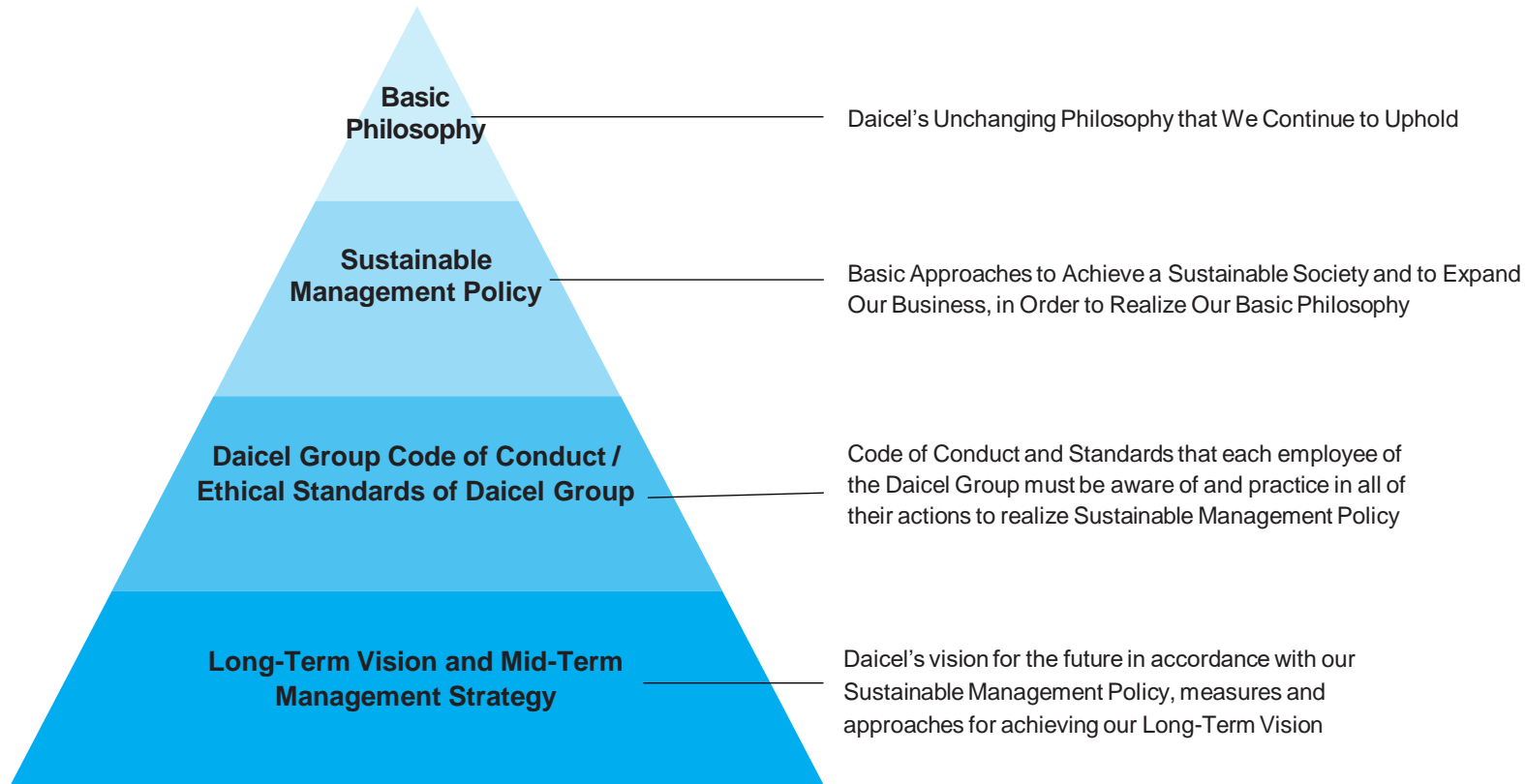

Sustainable Management Policy

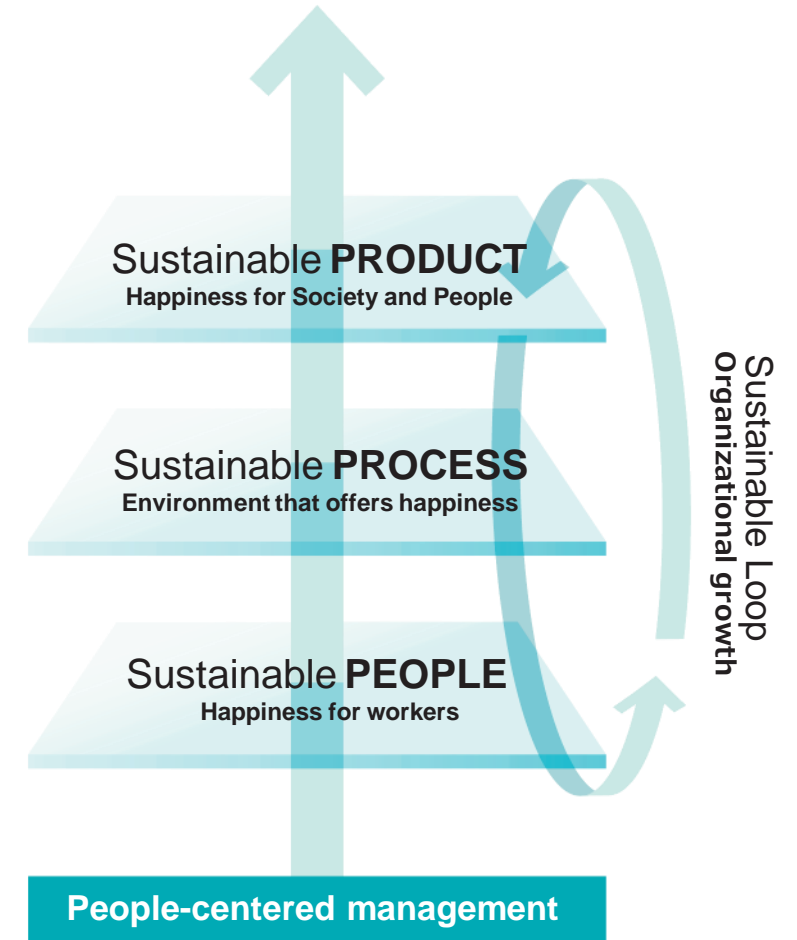

Daicel efforts to create a bright future



Since our founding, Daicel has valued the spirit of co-existing with others. With the goal of enriching people's lives, we have developed and provided materials that benefit society for over 100 years. Today, conditions influencing society and the environment are moving towards paradigm shift. Amid such change, Daicel engages in daily R&D activities towards building a circular society, uniting with like-minded individuals to expand our value co-creation. Daicel will continue to explore the limitless possibilities of chemistry as we fearlessly embrace the challenge of innovation. Our goal is to pass on world-class monozukuri manufacturing to future generations.

Creating a bright future

Nanodiamond Solutions
For example, technology for achieving carbon-negative through super-solar reduction

Selective adsorbents
Cellulose has been a key part of our lives since ancient times. Discovering new possibilities in semiconductor manufacturing.

DAICEL Production Innovation
Sweeping innovation in manufacturing in pursuit of total optimization.

Actranza® lab
This innovative drug delivery system injects chemical solutions through the skin to reach the target cells
*For animal testing

BELLOCEA® S7
Biodegradable spherical particles that provide smoothness and moisture to cosmetics

Micro Plants
Technology for achieving the ultimate in energy-less plants

Forest chemistry
Technology for melting wood without causing an environmental load

DAISI
ONE TIME ENERGY® for single-use, instantaneous energy when its needed most

Excipients for drugs and food
A drug and food excipient that causes the tablet to break down upon contact with water

CAFBL0™
An acetate cellulose with superior marine degradability that is made from environment-friendly natural materials

<https://www.daicel.com/mirai/>
(Japanese web site)

About DAICEL



The Daicel Group is comprised of over 10,000 employees working at 75 companies in 14 countries and regions around the world, and the Group continues to engage in business activities that contribute to a sustainable society.

To accelerate Group growth and increase corporate value, it is important to increase net sales and income and maintain a healthy balance sheet while improving capital efficiency and asset efficiency. Currently, we are working to continue increasing revenues and income by improving the profitability of our core businesses and expanding sales in growth domains. At the same time, we are striving to further increase EBITDA and achieve an ROIC of 10% by FY2026. We set the target of DOE 4% or more and a total return ratio of 40% or higher as a baseline while working to further increase shareholder returns.

FY2024/3

Consolidated net sales **¥ 558.1 bn**

Consolidated operating income **¥ 62.4 bn**

EBITDA **¥ 96.1 bn**

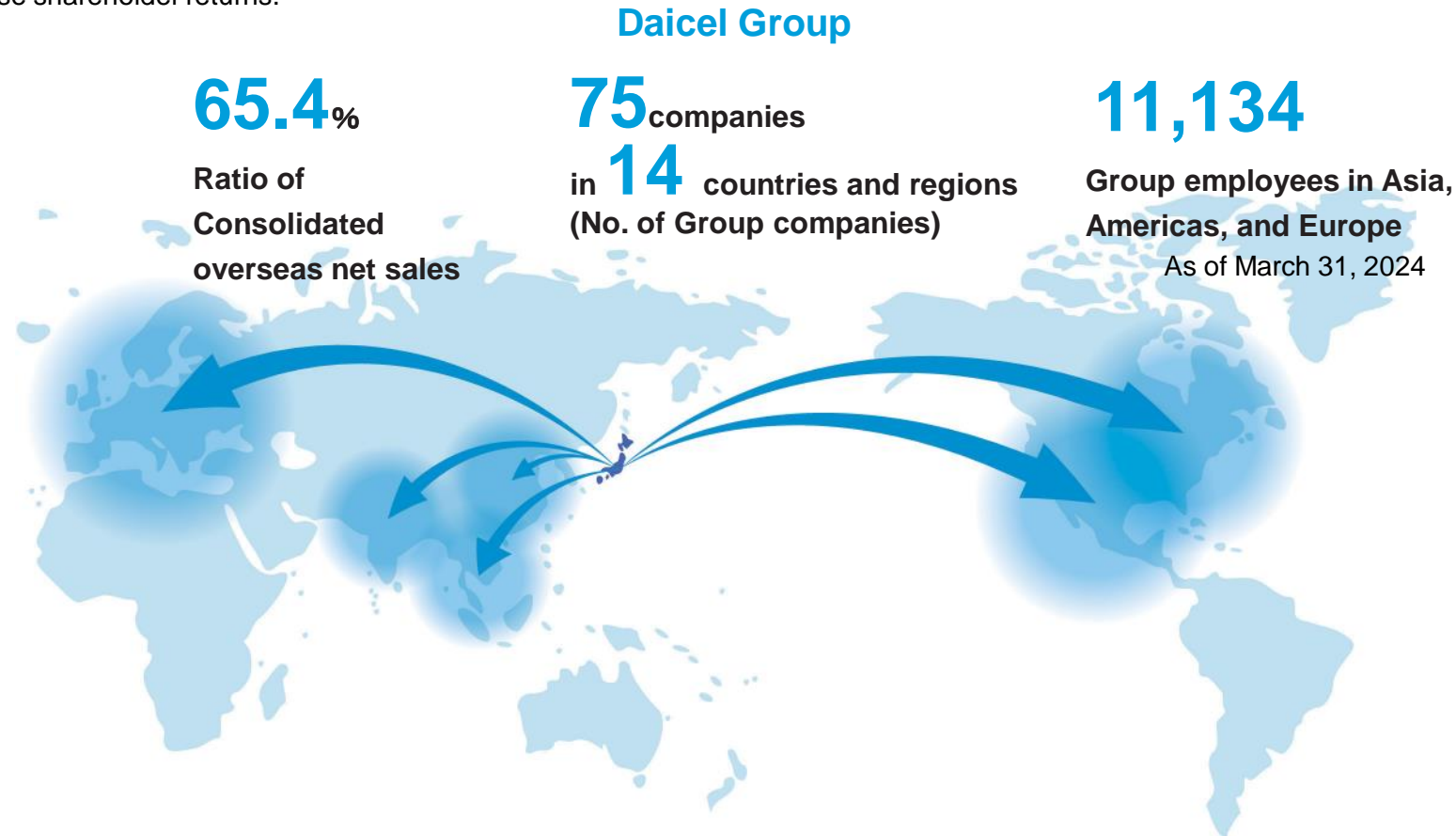

Celluloid is the world's first industrialized plastic. In Japan, domestic production of raw materials began in the 1900s. Later, in 1919, a merger between eight domestic celluloid manufacturers resulted in the formation of Dainippon Celluloid Co., Ltd. (modern day Daicel). Daicel had continuously engaged in product development aligned with the needs of the times, providing various materials that benefit people's daily lives. We are also engaged in production technology development, pursuing dynamic methods to innovate production, save energy, and conserve resources at chemical plants. Daicel will continue to explore the limitless possibilities of chemistry as we fearlessly embrace the challenge of innovation.

Three Strengths of Daicel

1 Pioneer in biomass chemistry

Since our founding in 1919, we have been involved in biomass chemistry, which creates chemical products from plant-based raw materials. Starting out as a celluloid business using raw materials made from the cotton plant and parts of the camphor tree, we later commercialized a cellulose acetate that addressed the material's flammability issues. Today, we continue to supply biomass products to various market sectors.



Cellulose acetate

2 Unique technology cultivated since our founding

From the construction of acetyl chains for manufacturing acetic acid derivatives to the production of high-performance engineering plastics boasting a global share, we use innovative technologies to deliver products to the world.

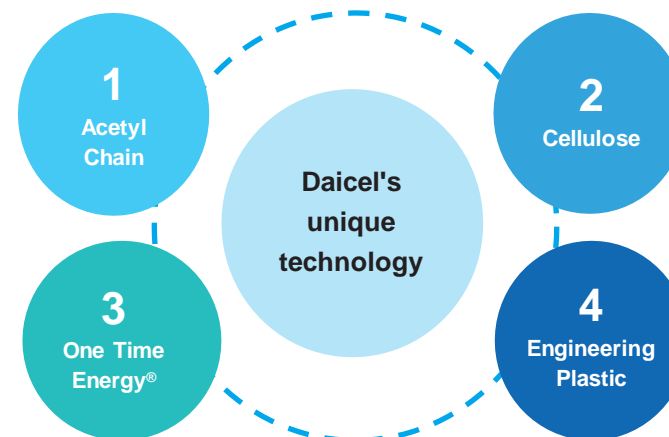

3 Daicel Production Innovation for better efficiency

As a chemical manufacturer the foundation of Daicel's monozukuri manufacturing is supported by our unique production innovation. We have visualized the knowhow related to nearly 8.4 million plant operations possessed by our experienced operators and incorporated that knowledge into an operations support system. This has enabled us to increase our production efficiency nearly three-fold*. In 2020, we successfully developed an autonomous production system, which incorporates AI to achieve further advancements. In addition to safety and quality, this system also contributes to CO₂ emission reductions by optimizing energy use. We are in pursuit of the ultimate level of production efficiency.

*Results from Daicel Aboshi Plant



Control room of the Integrated Production Center (IPC)

[DAICEL Production Innovation](#) | [Daicel Corporation](#)

Daicel Group by Product Lines and Technical Field



With its origins in the celluloid business, Daicel has used that technical knowhow as a foundation for developing four new technical fields. Cellulose chemistry uses natural materials as raw ingredients. Organic chemistry is used to formulate powerful acetyl chains. High polymer chemistry was cultivated through research on various resins. And, One Time Energy® developed from pyrotechnic composition technology. These four core technologies support the Daicel Group's business domains and help us make contributions that address the diversifying needs of modern society.

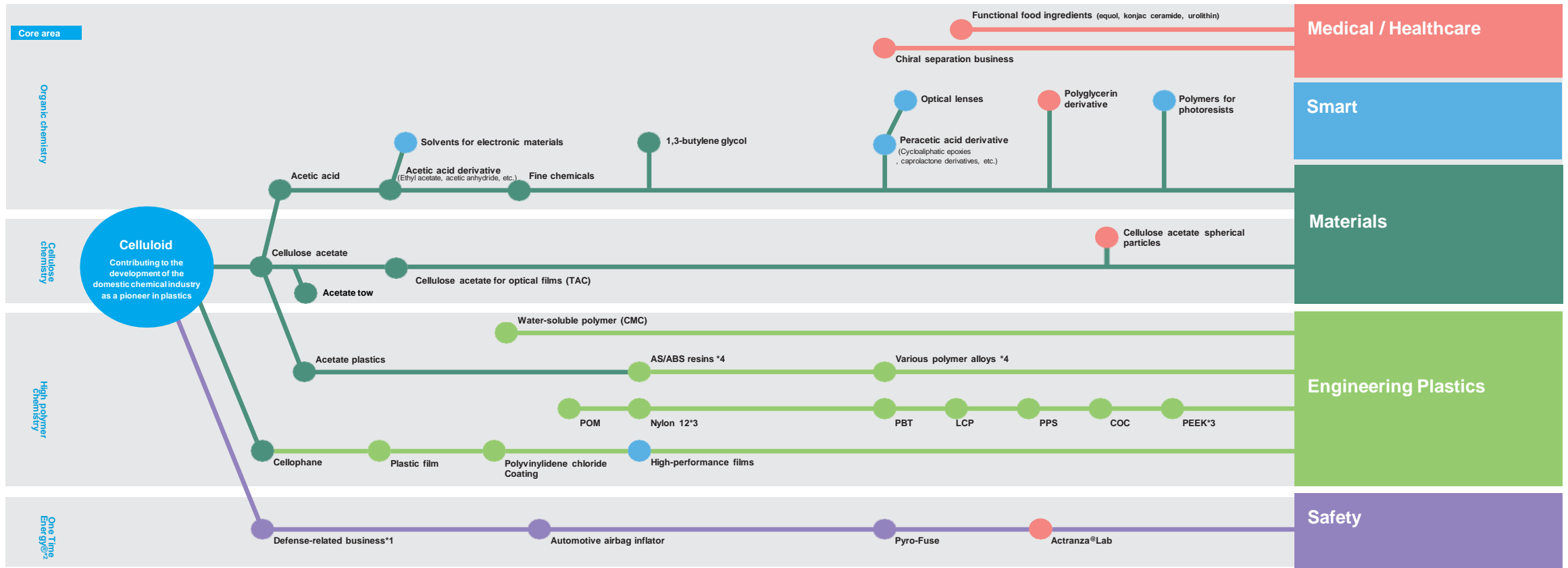

*1. Withdrawn from the business.

*2. One Time Energy®: Pyrotechnic composition technology cultivated through the inflator business. This technology safely, accurately, and instantaneously generates the optimal energy on a one-time basis.

*3. Product by Polyplastics-Evonik Corporation.

*4. ABS resin and various polymer alloys were transferred to Novacel Co., Ltd. established in 2024.

Daicel Group Business

FY2024/3 Consolidated net sales
¥ 558.1B



Medical / Healthcare

Net sales
¥13.9bn
Composition
2.5%

In a society that values QOL, we provide safe, high-quality healthcare materials and solutions related to pharmaceutical development.

Chiral columns



Chromatography columns for separate optical isomers. We contribute to the provision of safe pharmaceuticals by separating active pharmaceutical ingredients.

BELLOCEA®
(spherical cellulose acetate for cosmetics)



As a marine biodegradable material, this is expected to contribute to solving the marine plastic waste problem in the cosmetics industry.

Smart

Net sales
¥33.8bn
Composition
6.1%

Providing the electronic materials market with new solutions that support pleasant lifestyles and technological innovation.

Cycloaliphatic epoxies



The world's only manufacturing method to delivery low impurities and be chlorine-free, enabling use in electrical materials where quality, reliability, and durability are required. This technology is also garnering attention for use in EV applications.

Solvents for electronic materials

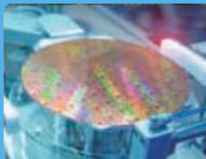

High purity, low metal solvent production and quality control system with a proven track record in semiconductor process Applications.

Safety

Net sales
¥95.6bn
Composition
17.1%

Using One Time Energy®, technology cultivated through our airbag inflator business, for which we boast a strong share of the global market, to provide safety and peace of mind to a wide range of industries.

Inflator for vehicle airbags



Started supplying the key component for automobile airbag systems that protect passengers in the event of a collision.

Pyro-Fuse



Supporting safe daily living by expanding One Time Energy® technology (developed in the course of producing inflators) to industrial applications other than Automobiles.

Materials

Net sales
¥182.2bn
Composition
32.7%

Providing value to a wide range of industries on the strength of a diverse line of products centered on acetyl chains and our unique manufacturing methods.

Acetic acid



Japan's only acetic acid manufacturer. Acetic acid is also an environmentally friendly raw material plastic products, and we provide solutions as an environment-friendly material.

For optical film Cellulose acetate (TAC)



Utilizing excellent optical properties, transparency, and smoothness to develop into a polarizing plate protection film for LCDs.

Engineering Plastics

Net sales
¥226.8bn
Composition
40.7%

Using technical skills cultivated through our work as a pioneer in engineering plastics to provide highly functional and high-value-added solutions to a wide range of industries.

Polyacetal (POM)



Used in a wide range of applications including vehicles, electronics & electricity, and industrial equipment, this material has contributed to the development of major industries across generations.

Liquid crystal polymers (LCP)



Widely used for ultra-compact precision connectors in the latest IT equipment, such as tablets and smartphones, which have become increasingly smaller, to support social infrastructure.

*Figures for other segments not included in net sales or composition ratio.

Net sales and operating income by segment for FY2024/3 is the figure after segment changing in the TAC, Epoxy Compounds and Caprolactone Derivatives.

Major businesses

→ Life Science, Healthcare

In the life science business, we boast the world's top share for the manufacturing, sales, and contract separation services related to chiral column, which are used for separating and purifying optical isomer in the medical field. In recent years, we are also aggressively expanding business into the bio sector. In the healthcare business (cosmetics and health foods), we are striving to contribute to QOL* by developing and offering high-quality raw materials for cosmetics and health food ingredients derived from natural ingredients.

*QOL: Short for quality of Life. Refers to the quality of life in terms of not only material wealth, but also mental health.

FY2024/3 results

Net sales

¥13.9bn

Operating income

¥0.8bn

Daicel Strengths

1 Life Science: Leading company for chiral separation technology

The world's first successful industrialization of chiral (optical isomer) columns. Along with continuing to advance separation technology, we are also building a global network with related pharmaceutical companies and researchers.

2 Life Science: Unique medical materials business

Promoting business synergy through collaborations between medical-related companies within the group on new needle-free drug administration devices and high-function plastic products used as medical materials.

3 Healthcare: Unique manufacturing technology

For cosmetics, we can manufacture colorless and transparent polyglycerin with few by-products and high water solubility. For health foods, we apply our unique fermentation technology to use biotechnology to engineer intestinal metabolites that are difficult to produce in the body.

Major products

Life Science business

Chromatographic columns/stationary phases (chiral columns and achiral columns), chiral reagents, separation services/purification services, analytical services, reagents for genetic analysis research, pharmaceutical additives, new drug delivery devices



Chiral columns

Healthcare business

- Raw materials for cosmetics (Polyglycerin derivatives, BELLOCEA®, spherical cellulose acetate for cosmetics, etc.)
- Health food ingredients (Equol, konjac ceramide, URORICH®, etc.)



Raw material for cosmetics: BELLOCEA®

Major businesses

→ Functional Products, Advanced Technology

In the Smart business, we provide materials and solutions primarily to the electronics market. In the Functional Products business, we handle alicyclic epoxies, which have a unique manufacturing process, and caprolactone derivatives. In the Advanced Technology business, we manufacture high-performance photoresist materials used in the semiconductor manufacturing process, solvents for electronic materials, and functional films with the anti-glare and strength required for various displays, from smartphones and tablets to automotive applications.

FY2024/3 results

Net sales

Operating income

¥33.8bn

- ¥0.9bn

■ Daicel Strengths

1 Market-in solutions to respond to market needs

On the electronics market, we use our material design and manufacturing technology for synthetics, compounding, coating, and a variety of other applications to provide solutions and value that respond to customer needs, from materials to module parts.

2 World's No. 1 share of alicyclic epoxy

Manufacturing high-quality Cycloaliphatic epoxy via the world's only manufacturing method. The use of a manufacturing method that does not involve the use of chlorine, which is corrosive to metals, provides high-quality, highly reliable compatibility with electronics and electrical materials as well as mobility materials for EV.

3 Providing safety and responding to evolving needs

We possess the technical skills and stable provision capacity to respond to the high-level quality demands of the semiconductor industry. Our track record enables us to provide customer-oriented product development and respond to evolving new demands such as materials for use in organic semiconductor sensors.

■ Major products

Functional Products

Cycloaliphatic epoxy, Caprolactone derivatives, Optical lenses



Cycloaliphatic epoxies for EV motors (application example)

Advanced Technology

Polymers for photoresists, Solvents for electronic materials, High-performance films



Solvents for electronic materials (Sample application of the semiconductor manufacturing process (front-end process))

Major businesses

→ Mobility, Industry

Inflates an airbag within a few milliseconds after detecting a vehicle collision. Vehicle airbag inflators (gas generating systems), which protect the lives of vehicle passengers and pedestrians, are the mainstay product of the Safety business. We call the safety mechanism cultivated through the inflator business One Time Energy® and are expanding this technology to applications other than airbags. One example is a pyro-fuse that safely and instantly interrupts high voltages and large currents in an emergency. We also are anticipating applications in various industries as automation spreads due to the increasing adoption of EVs and AI.

FY2024/3 results

Net sales

Operating income

¥95.6bn

¥3.0bn

■ Daicel Strengths

1 Inflator technology cultivated over several years

Since commercializing vehicle airbag inflators in 1988, we have engaged in one-stop production, starting from gas generating agents, to contribute to high reliability and user safety.

2 Toyota Production System meets DAICEL Production Innovation

Using the DAICEL Production Innovation approach as a foundation, we applied the Toyota production method to pursue high quality and productivity.

3 Advanced integrated management (image analysis) systems

Achieved quality management at the serial unit level through an integrated management system developed in collaboration with Hitachi, Ltd. We are expanding this system globally as a standard. Building strong trust-based relations with customers on a foundation of high-level quality management.

■ Major products

Mobility

Automotive airbag inflators



Automotive airbag inflators

Industry

Pyro-fuses and gas generators for and seat belt pretensioners (PGG)



Pyro-fuses

Major businesses

→ Acetyl, Chemical

As Japan's only manufacturer of acetic acid, which has a diverse range of uses, we provide various materials to a wide variety of industries. We develop acetic acid and other chemical products made from acetic acid, cellulose acetate made from cellulose extracted from wood and cotton, and acetate tow made by spinning cellulose. We hold the world's top share of TAC*, which is used in optical films, and also have a large share of acetate tow worldwide.

FY2024/3 results

Net sales

¥182.2bn

Operating income

¥40.8bn

■ Daicel Strengths

1 Optimal plant operations through DAICEL Production Innovation

Built an automated production system that led to the evolution of the Daicel Production Innovation. Through optimal plant operation, we have achieved safety, quality, stable supply, and increased cost competitiveness in the manufacturing process..

2 Building strong acetyl chains

As Japan's only acetic acid manufacturer, we manufacture and sell acetic acid and acetic acid derivatives. As part of the manufacturing processes for these products, we have established a circular manufacturing system that collects, purifies, and reuses acetic acid generated as a byproduct at customer factories and Daicel Group plants.

3 Technical support leveraging our technical capabilities

Utilizing our accumulated experience in controlling the physical properties of cellulose, a natural material, and processing technology, we provide technical support globally for cellulose acetate and acetate tow in response to customer needs.

*TAC: Tri-acetyl cellulose

■ Major products

Acetyl

Acetic acid, Acetic anhydride, Acetate tow



Acetate tow

Chemical

Cellulose acetate for optical films (TAC), Cellulose acetate, 1,3-Butylene glycol(1,3-BG), Organic solvents such as Ethyl acetate, Ketene derivatives, Ethylamine

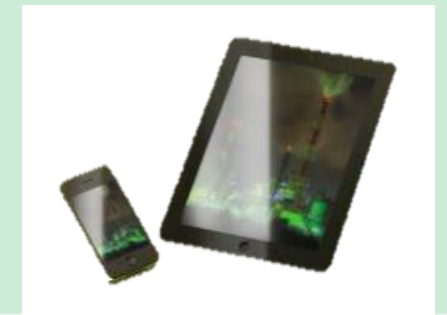

Cellulose acetate for optical films (application example)

Major Group Companies

→ Polyplastics, Daicel Miraizu

Polyplastics is a leading company in the field of engineering plastics, which have special properties such as mechanical strength, heat resistance, and chemical resistance, and contributes to making automobiles lighter and more electrically equipped, and improving the performance of electronic devices. Daicel Miraizu sells a variety of products to a wide range of industries, including AS resins, which have multipurpose uses ranging from daily necessities to automobiles, and water-soluble polymers (such as CMC*1) for EVs, which have been attracting attention in recent years.

1: Sodium Carboxymethyl Cellulose (CMC): CMC Daicel is a water soluble polymer developed using Daicel's proprietary technology. CMC is made from cellulose, a natural material

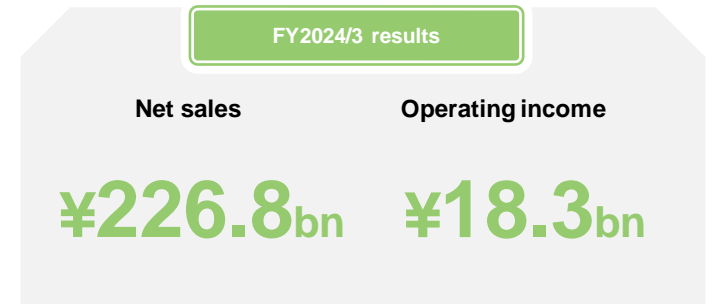

■ Daicel Strengths

1 Polyplastics: Ability to develop new applications

As a group of experts in the engineering plastics industry, we work with our customers to develop applications that respond to major industries (such as the electronics and automobile industries) and social needs that change with the times. We provide optimal solutions by combining the wide-ranging product lineup of our Group companies.

2 Polyplastics: Technical solutions spanning major regions

Technical solution centers located in six locations across Asia, Europe and the US collaborate with each other. We provide consistent solutions globally, from material formulation design to molding processing support.

3 Polyplastics: Advanced manufacturing technology and quick delivery of consistent quality

By combining the engineering plastics manufacturing technology we have accumulated over more than 50 years with DAICEL Production Innovation, we are promoting further sophistication of production.

■ Major products

Polyplastics

Polyacetal (POM), polybutylene terephthalate (PBT), polyphenylene sulfide (PPS), liquid crystal polymer (LCP), cyclic olefin copolymer (COC)

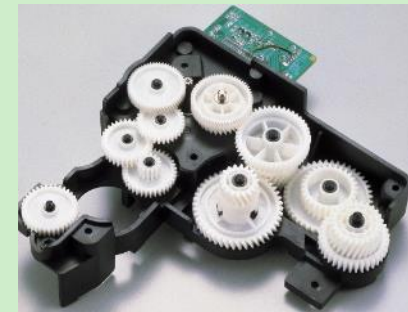

Gears using polyacetal (POM)

Daicel Miraizu

AS resin, water-soluble polymers, barrier films for packaging



Lithium ion battery that uses CMC

Long-Term Vision and Mid-Term Management Strategy



We outlined DAICEL VISION 4.0, our Long-Term Vision, and Accelerate 2025, our Medium-Term Management Strategy based on that Vision. Working to achieve this Vision and Strategy, the Daicel Group is striving for a balance between a sustainable society and business growth for our Group. Achieving this goal will require that we break free from conventional social systems based on an assumption of mass production, and we believe this will require four major structural shifts (chart below). Through these initiatives, Daicel will work with like-minded partners towards contributing to the formation of a circular society.

Structural shift outlined in our Long-Term Vision and Medium-Term Management Strategy that will enable Daicel to contribute to the building of a circular society

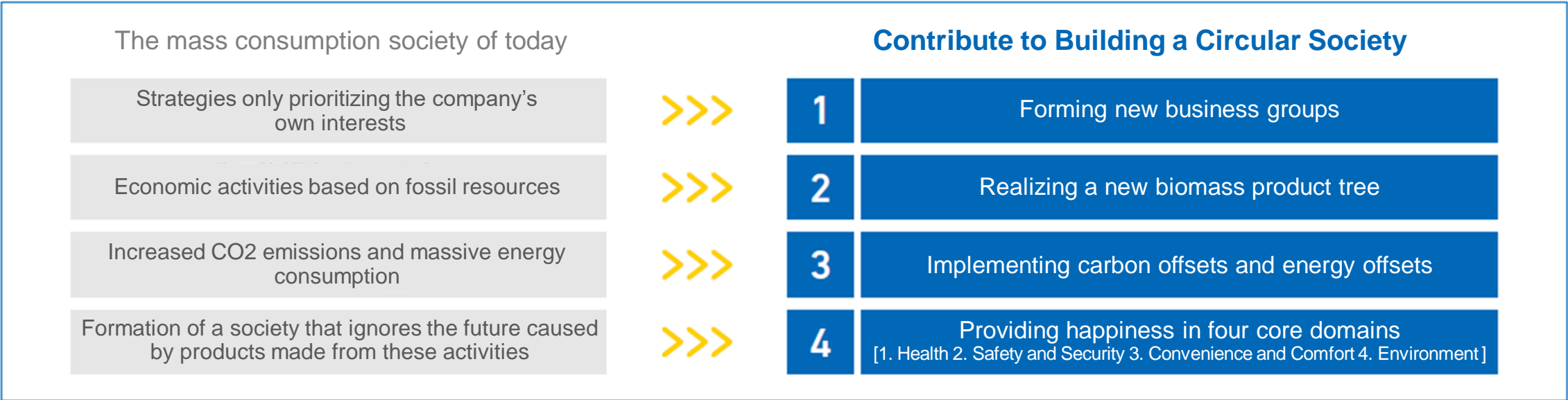

Formation of new business groups

To change social structures, it is essential that we form new business groups that can work together to create new value for society and the environment. Our monozukuri manufacturing is just one of the processes that results in a final product, and many of these processes are connected to form a supply chain. By combining the strengths of each connected company, we can manufacture products more efficiently than any single company could through trial and error. This will lead to the creation of better products and the discovery of more environment-friendly manufacturing methods. These new groups of companies that have vertical connections between companies while also being connected horizontally, such connections between companies in the same industry, are called a cross-value chain. The diagram below shows the path to achieving this cross-value chain step-by-step through three operations (OP) by expanding the scope from Daicel (parent) to Daicel (Group) and to partners.

Growth and acceleration curves

Operations to realize our Long-Term Vision

Original DAICEL

(The area including domains on which we focus in addition to current business)

- Transformation of the business structure (Selection and concentration of the business ⇒ Shifting to value providing type of organization)
- Transformation to asset light
- Structural reforms to accelerate the growth of OP-II/III

New DAICEL

(Peripheral areas of existing business to be expanded through M&A or collaboration)

- Business restructuring, drastic review of existing JV
- Transformation to asset super-light
- A company creating high added value which can aim at OP-III

New Business Group

(Cross-Value Chain which brings vertical integration type of supply chain along with horizontal integration)

- Not limited to M&A, constructing No.1 supply chain with various connections

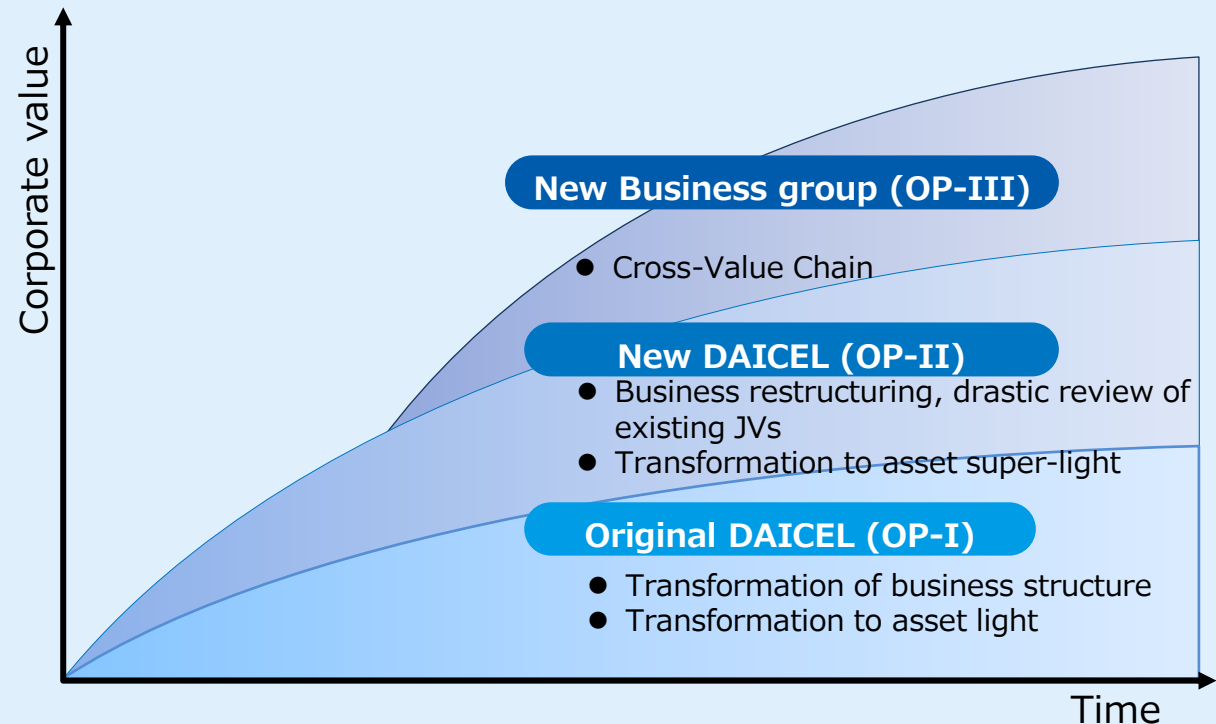

Long-Term Vision and Mid-Term Management Strategy

Biomass Value Chain (BVC) Concept

Japan, a country where nearly 70% of national land is covered by forests. Trees older than 50 years do not absorb CO₂ and are largely left untouched. We developed technology for melting wood, which can be difficult to melt, under mild conditions and with less environmental impact, enabling the use of forestry as an alternative to petrochemical raw materials. Regenerate into forests that easily absorb CO₂ and have high soil water retention to promote the circulation of industrial resources. This is Daicel's concept of a biomass value chain (BVC). To achieve this vision of creating a circular industrial ecosystem, it is essential that we gain the support and understanding of many people, and that we achieve co-creation through collaboration between industries.



Reviving forests through forest regeneration



Regenerating marine resources by improving water quality



Fertilization of farmland by regenerating deciduous broad-leaved forest areas

Creating a sustainable, circular industrial ecosystem for Japan's future.

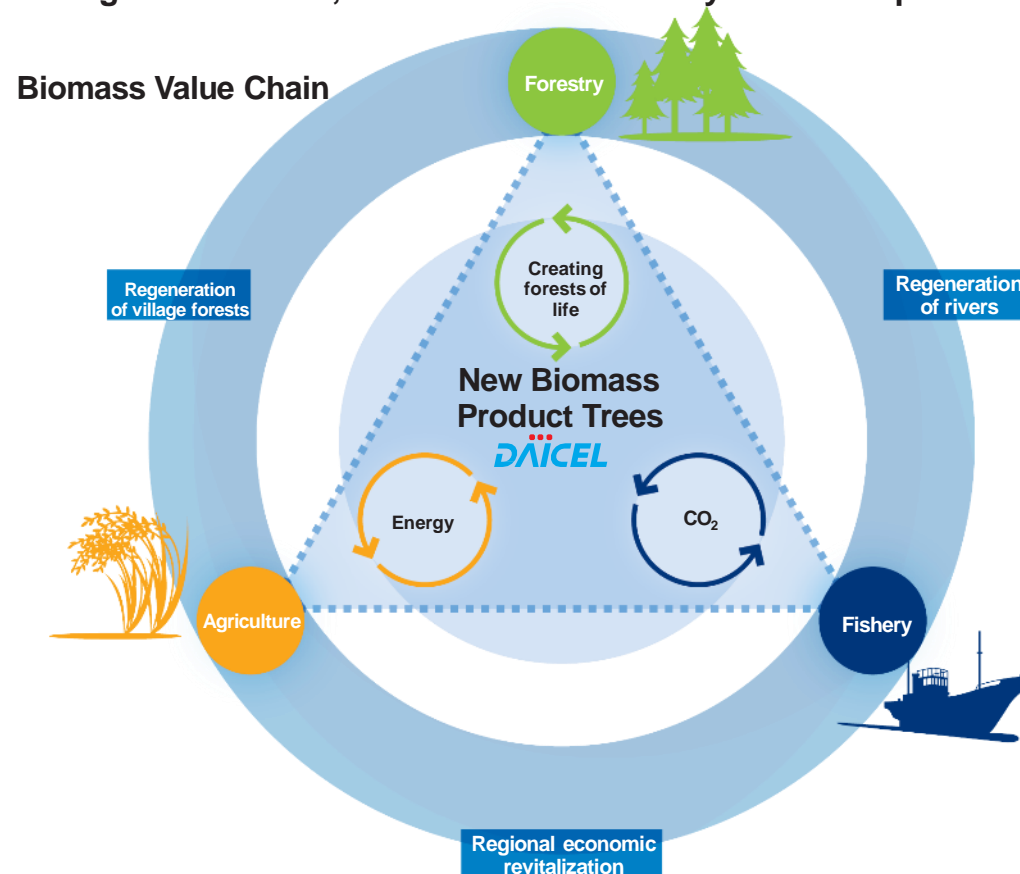

New biomass product trees

The key to realizing the BVC concept is new biomass product trees. Providing sustainable products is the mission of a materials manufacturer. However, the processes we use must also be sustainable. Embracing the theme of not wasting any part of a single tree, we developed technology for processing all types of materials while limiting environmental load to the bare minimum to create highly functional products from natural materials. As a company involved in biomass materials, since our founding we have aimed to achieve carbon neutrality. We are applying the power of chemistry towards achieving a balance between ecology and economy and building a circular society.

Collaborative technology development through academia-industry partnerships

We are promoting technical collaborations with universities to formulate new biomass product trees and achieve a balance between ecology and economy. For example, microfluidic devices (see P19), which are the key to reducing the footprint of chemical plants, and "ultra mild melting", which decomposes wood at low costs and with a low environmental impact.

Long-Term Vision and Mid-Term Management Strategy

Achieving carbon neutral/negative

Daicel is promoting decarbonization efforts to achieve carbon neutrality in 2050. As a measure to achieve this, we will build a biomass value chain that we aim to achieve by mutually linking and promoting technological innovation in fields such as process, production, and energy, and achieve a "carbon negative" status in which CO₂ emissions are lower than absorption. Our group strives to achieve both ecology and economy through technological innovation.

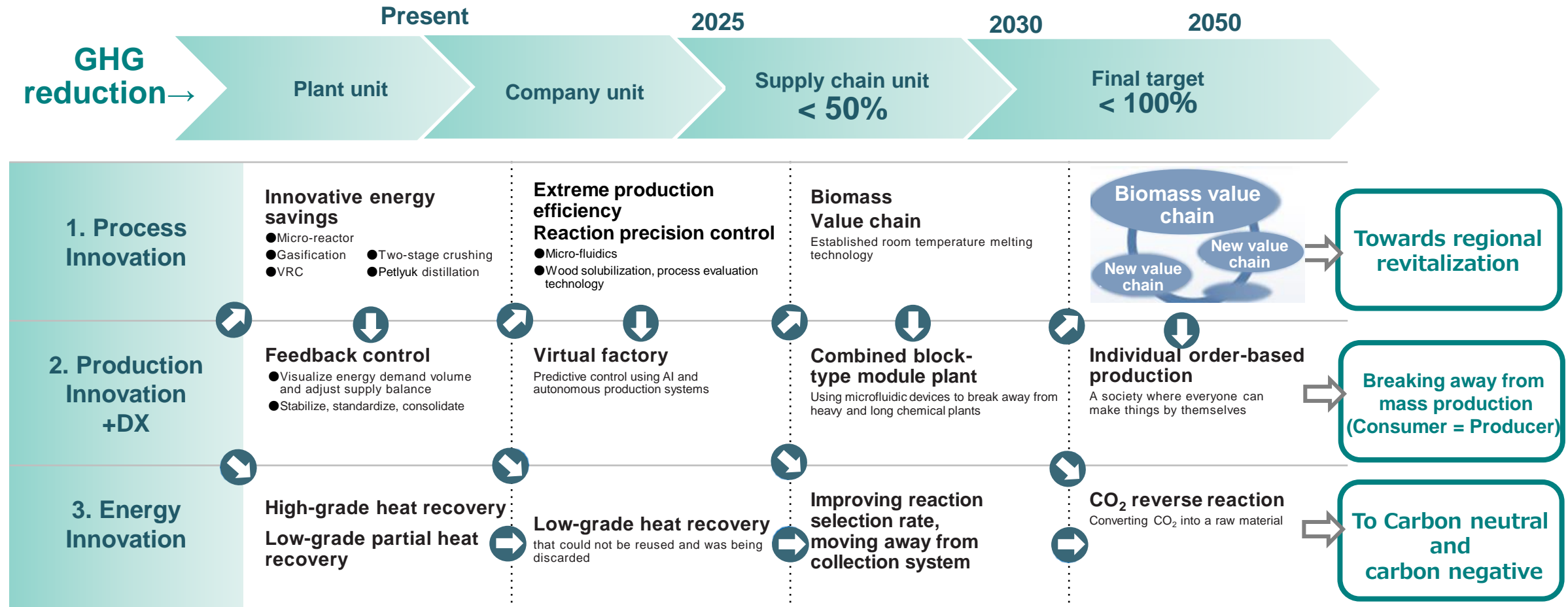

Long-Term Vision and Mid-Term Management Strategy

Providing happiness through four core domains

Daicel aims to manufacture products that contribute to happiness for society and people. Among the numerous social issues facing society, in our Long-Term Vision we identify four core domains: Health, Environment, Safety and Security, and Convenience and Comfort. We view these areas as domains that will see increased needs in the future and in which we can leverage the strengths of our Group, and are choosing specific markets in each field on which we will focus.

Health	Environment	Safety & Security	Convenience & Comfort	
<p>Medical materials</p> <ul style="list-style-type: none"> • DDS*/Medical equipment • Medical equipment/packaging materials (engineering plastics) <p>Vital sensors</p> <ul style="list-style-type: none"> • Nano diamonds <p>Functional food ingredients based on intestinal metabolites</p> <ul style="list-style-type: none"> • Equol • Urolithin <p><small>*DDS...Drug delivery systems</small></p>	<p>Environmentally friendly solution business, Green chemicals</p> <ul style="list-style-type: none"> • Reevaluate existing in-house chemical chain • Truly spherical particle BELLOCEA® • Fine cellulose • New cellulose derivatives 	<p>Support for electric vehicles</p> <ul style="list-style-type: none"> • Mass production of pyro-fuses • Expanding sales of inflators and current breakers to China, Europe and America <p>Fusing with sensing technology through B2B collaborations</p> <ul style="list-style-type: none"> • Engaging in lifestyle safety equipment market • Injury prevention equipment featuring fall detection 	<p>Developing and deploying new functions by improving processing technology</p> <ul style="list-style-type: none"> • Film technology • Coating technology <p>Inorganic & organic composite electronic materials</p> <p>Materials for electronic devices</p> <ul style="list-style-type: none"> • Optical lenses, etc. 	
<p>Accelerating new business through Translating Functions</p>				
<p>New drug delivery devices</p> <p>Actranz® Lab (For Animal Testing)</p> 	<p>Fine cellulose</p>  <p>Provided cutlery made from marine biodegradable cellulose acetate resin used at the G7 Hiroshima Summit in May 2023</p>	<p>Pyro-fuses for EV</p>  <p>Plan to launch in FY 2026/3 for European customers</p>	<div style="display: flex;"> <div style="flex: 1;"> <p>Power Electronics</p>  <p>Achieved cost reductions and performance improvements by increasing Si content</p> </div> <div style="flex: 1;"> <p>Semiconductor masking</p>  <p>Received the 2023 Semiconductor of the Year Excellence Award (Semiconductor electronic materials division)</p> </div> </div>	
<p>First, we will aim to develop medical device business in Japan, Europe and America</p>	<p>2031/3 sales target: Exceed ¥40bn</p>	<p>2031/3 sales target: Exceed ¥40bn</p>	<p>2031/3 sales target: Exceed ¥50bn</p>	

Topic 1 Balancing Between Ecology and Economy

- From mass production and consumption to individual orders and production -

Aiming for environment-friendly processes to create environmentally-friendly products

Microfluidic devices represent the application of Daicel's unique melting technology into chemical plants. Microfluidic devices suppress impurities and enable precision control of internal channels. By applying our technology for melting wood at room temperature, we make it possible to suppress the generation of impurities and enable precision control of flow channels.

Creating a society where people can benefit from the joy of monozukuri manufacturing on the individual, family, and community level

Modern chemical plants

Energy-intensive mass production
Heavy, long facilities
(large-scale refining processes) Major temperature/concentration distribution
Unable to produce just the desired product (low efficiency)

Microfluidic devices

Produced when and where needed
Small size and desktop design (no refining processes required)
Minor temperature/concentration distribution
Make only the desired product (ideal reaction)



Topic 1 Balancing Between Ecology and Economy

- From mass production and consumption to individual orders and production -

Features of Microfluidic Device Plant

1) Micro-miniaturization of production facility

Glass substrates the size of a business card are combined together to form a single unit. Combinations of glass substrate channel designs can be used for all kinds of chemical products and production volume can be increased by parallelizing one unit. Moreover, laboratory results can be reproduced for industrialization simply by increasing the number of glass substrates.

2) Energy saving

There is no unevenness in temperature and pressure in ultra-fine channels, allowing pinpoint and speedy generation of targeted reactions. Since wasteful reactions are unlikely to occur, the purity of the product is high and there is no need for post-processing to separate out the excess material. The technology to be adopted at the resist polymer manufacturing plant of Arai plant is expected to reduce both energy consumption and CO₂ emissions by more than 90%.

3) Liberalization of production facility

Since this technology allows building ultra-compact, energy-saving, low-cost facilities, it dramatically increases the flexibility of production sites. Locating production sites where raw materials are available facilitates local production for local consumption and greatly reduces transportation costs and energy.

Flow path size:
several tens to several hundreds of μm x several meters

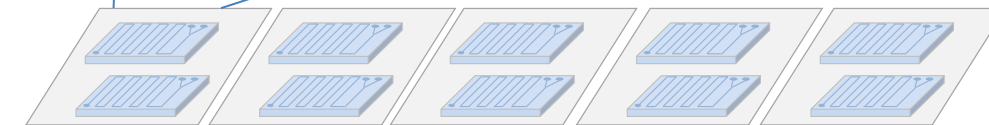
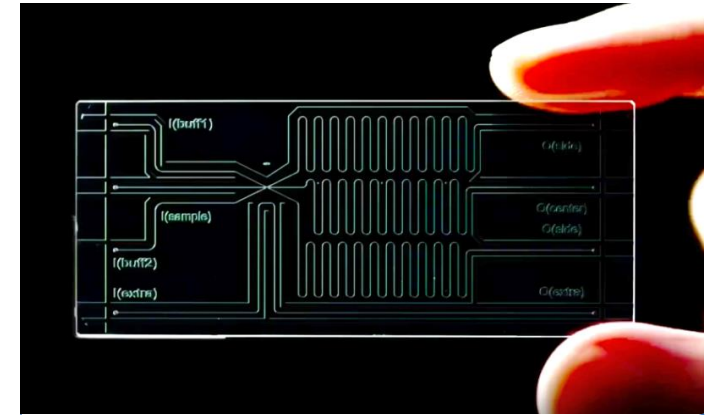

1 flow path = 10 plates in series (10D)

Topic 2 Initiatives towards establishing a Circular Society

Nanodia Solution that turns CO₂ into resources, and new materials gained through melting technology

World's first technology using sunlight to semi-permanently decompose CO₂

Daicel has acquired technology that can generate nanodiamonds with an extremely high rate of efficiency using the pyrotechnics technology cultivated from our manufacturing technology used for airbag inflators. By engaging in application development, we succeeded in developing technology that decomposes CO₂ using only sunlight. We have demonstrated that CO₂ can be continuously decomposed into carbon monoxide and oxygen at a high rate of efficiency without using a large amount of electricity when decomposing CO₂. Instead, this method uses hydrated electrons generated in the surrounding space simply by irradiating sunlight. Nanodiamonds are ultra-small particles of 3 to 5 nanometers that are hard, chemically stable, do not react with any acid or alkali, and produce reactions that continue semi-permanently.

Technology that is the key to new biomass product trees

Thus far, petroleum resins have been chosen over wood because liquid petroleum is more soluble than solid wood, making it easier to create various reactants. To overcome this issue, we have been engaged in joint research with universities towards developing technology that melts wood using less energy. If achieved, this would create a new group of biomass products for a wide range of fields, offering the possibility of replacing or supplementing petrochemical products.

Development example

(MoCA*, a new material separated from wood powder)

By establishing a technology that selectively dissolves lignin and other substances contained in wood to separate cellulose, we succeeded in extracting the new material MoCA.



Wood powder



MoCA, a new material made through separation from wood dust

* Molecular Cellulose Assembly

Long-Term Vision and Mid-Term Management Strategy

The Daicel Group integrates a diverse array of businesses into 33 businesses and manages its portfolio in the “next generation,” “growth,” “foundation,” and “reform” categories.

Our businesses are categorized by industrial growth, competitive environment, sales growth, operating profit, and business characteristics. We perform a tilted allocation of management resources in line with the portfolio and regularly evaluate the results in terms of ROIC and sales growth rate.

Next Generation

- ◆ Cosmetic raw materials
- ◆ Contract pharmaceutical development and manufacturing*
- ◆ Health foods
- ◆ Analysis service
- ◆ Chiral reagents
- ◆ Genomics-related products
- ◆ Pyrotechnic devices for consumers
- ◆ High performance film
- ◆ Photoresist materials
- ◆ Optical lenses

Growth

- ◆ Solvents for electronic materials
- ◆ Inflater
- ◆ Caprolactone
- ◆ Alicyclic-epoxy-resin
- ◆ POM
- ◆ PPS
- ◆ LCP
- ◆ COC

Reform

- ◆ Cellulose acetate for fiber
- ◆ Resin compounds, cellulose acetate plastics, etc.
- ◆ OPS sheet*
- ◆ Container molding

Foundation

- ◆ Chiral columns
- ◆ TAC
- ◆ Acetate tow
- ◆ Acetic acid and derivatives
- ◆ Ketene derivatives/amines
- ◆ Low-density plastic foam products
- ◆ PBT
- ◆ Food packaging film
- ◆ CMC
- ◆ Chemical products, etc.
- ◆ Membrane products

◆ Medical / Healthcare ◆ Smart ◆ Safety

◆ Materials ◆ Engineering Plastics ◆ other

* Withdrewen by the end of March 2024

Long-Term Vision and Mid-Term Management Strategy

Performance and Management Index Targets



- Maintain the trend in increase in profit by improving profitability of foundation businesses and expanding sales in growth businesses.
- Further improvement in EBITDA
- Control expanding the size of balance sheet with the aim of getting ROIC 10% by fiscal year of March 31. 2027.

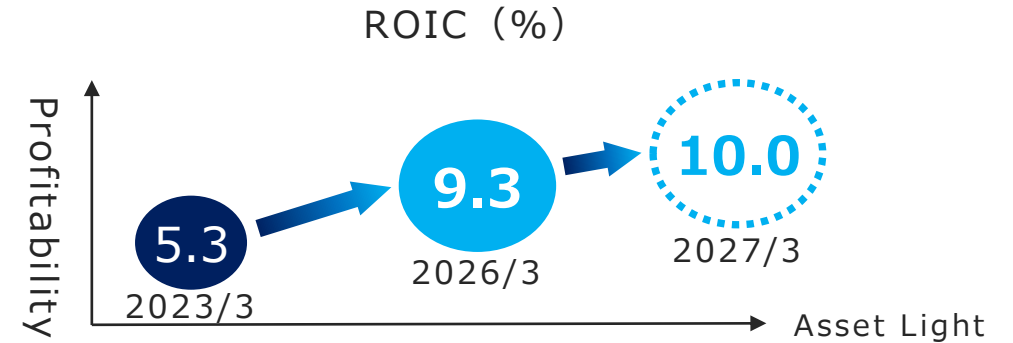
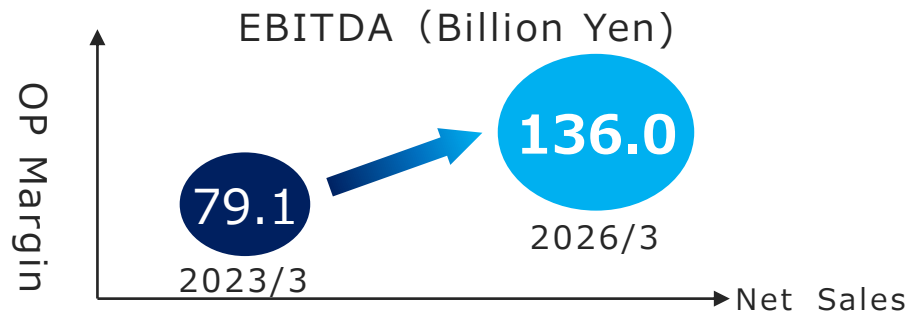

Unit: Billion Yen	2023/3 (Result)	2024/3 (Result)	2026/3 (Plan)
Net sales	538.0	558.1	660.0
Operating income	47.5	62.4	82.0
Operating profit margin	8.8%	11.2%	12.4%
Net income attributable to owners of the parent	40.7	55.8	58.0

Unit: Billion Yen	2023/3 (Result)	2024/3 (Result)	2026/3 (Plan)
EBITDA	79.1	96.1	136.0
ROE	14.3%	17.1%	17.1%
ROIC	5.3%	6.3%	9.3%
ROA	5.6%	7.0%	7.7%

Long-Term Vision and Mid-Term Management Strategy

Image of Balance Sheet



- Non-current assets increased due to the progress in growth investing.
- Minimize the increase in working capital due to the increase in sales.
- Improve efficiency of capital by quickly reducing strategically held shares.

Results as of end of March 31, 2023

Assets	Liabilities Equity
Current assets 406.6 Cash and deposits 93.5 Working assets 278.7	Liabilities 455.2 Interest-bearing debt 322.0
Non-current assets 300.1 Strategically held shares 58.9	Net assets 310.4
765.6	765.6

Target for end of March 31, 2026

Assets	Liabilities Equity
Current assets 370.0 Cash and deposits 60.0 Working assets 280.0	Liabilities 380.0 Interest-bearing debt 240.0
Non-current assets 350.0 Strategically held shares 20.0	Net assets 360.0
740.0	740.0

Unit: Billion Yen

Long-Term Vision and Mid-Term Management Strategy

Cash allocation



- Increase in profitability and enhancing capability of making capital by reducing CCC*¹ (target : 120 days / unit)
- Utilize increasing cash inflows for growth investment and shareholder return
- ➔ To raise the standard of revenue and further improvement of EPS*²
- Flexibility respond to the inorganic growth investments

Cash in

(3-year cumulative from the term ending at 24/3)

Operating CF	287.6
Cash	End of March 31, 2023 93.5
	Sale of strategically held shares 38.9
Debt financing	0~

Total distributable amount
420.0~

Cash out

(3-year cumulative from the term ending at 24/3)

Growth investment	190.0~
Shareholder Return	~85.0
Debt repayment	~85.0
Cash	60.0

*1 CCC = Cash Conversion Cycle

*2 EPS = Earnings Per Share

Unit: Billion Yen

Shareholder Returns

■ Shareholder return policy

Target a DOE 4% or more and a Total Return Ratio of 40% or Higher with Considering dynamic treasury stock acquisition

■ Status of shareholder returns

FY2025/3: Annual dividends forecasts :

60 yen per share (increase by 10 yen from previous fiscal year, DOE of 4.5%)

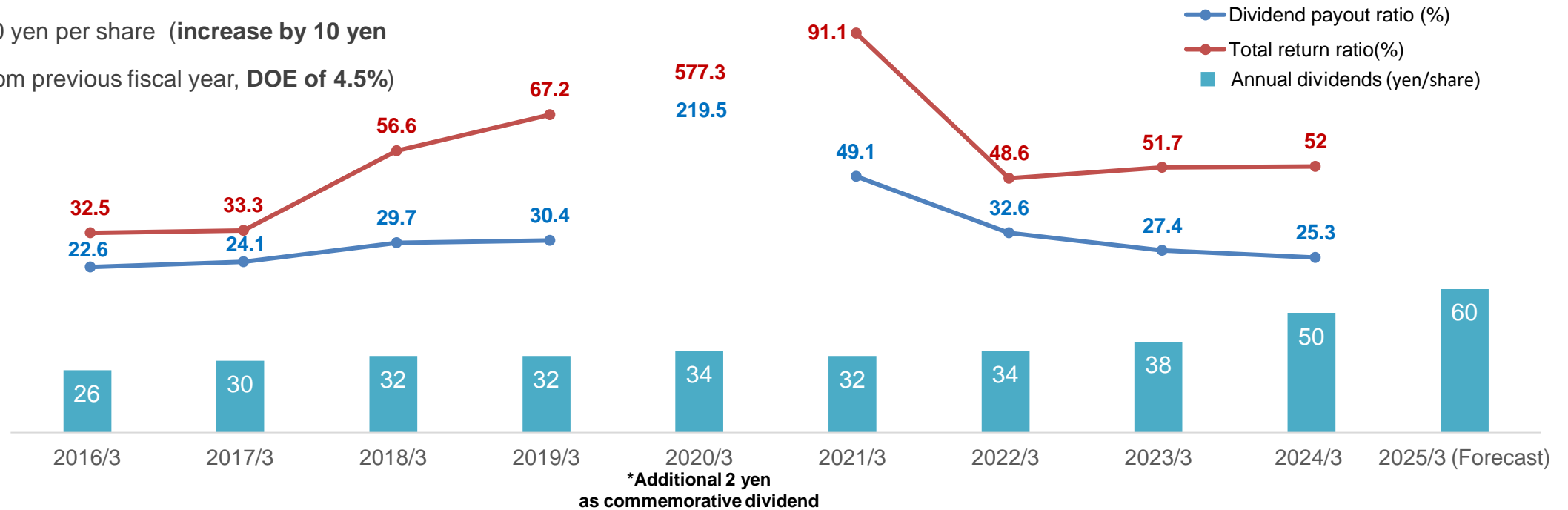

■ Recent status of treasury stock acquisition and cancellation

2020/3: Acquired approx. 17.8 billion yen in treasury stock, resulting in the cancellation of 16 million shares of treasury stock (ratio of total shares issued prior to cancellation: 4.82%)

2021/3: Acquired approx. 8.3 billion yen in treasury stock, resulting in the cancellation of 13 million shares of treasury stock (ratio of total shares issued prior to cancellation: 4.11%)

2022/3: Acquired approx. 5.0 billion yen in treasury stock.

2023/3: Acquired approx. 10.0 billion yen in treasury stock, resulting in the cancellation of 16 million shares of treasury stock (ratio of total shares issued prior to cancellation: 5.28%)

2024/3: Acquired approx. 15.0 billion yen in treasury stock. 2025/3: Resulting in the cancellation of 10 million shares of treasury stock (ratio of total shares issued prior to cancellation: 3.49%)

2025/3: Decision of acquisition of treasury stocks worth approx. 15.0 billion yen

Corporate Overview

Business name	Daicel Corporation
Establishment	September 8, 1919
Capital	¥36.2 billion
Number of employees	2,510 (Daicel Group: 11,134) As of March 31, 2024
Head office	Osaka Head Office Grand Front Osaka Tower-B, 3-1, Ofuka-cho, Kita-ku, Osaka Tokyo Head Office JR Shinagawa East Bldg., 2-18-1, Konan, Minato-ku, Tokyo
Listed exchange	Tokyo Stock Exchange Prime Market
Stock code	4202 (Chemical)
Transaction unit	100 shares

Domestic locations

- Office
- Training Center
- Research Center
- Plant



Appendix

Balance Sheet



(Unit : Billion Yen)

		Mar. 31, 2023	Mar. 31, 2024	Change
Total Current Assets		406.6	409.5	+2.9
	Cash, Deposits and Short-term Investment Securities	93.8	73.2	-20.7
	Notes and Accounts Receivable-trade	101.5	114.4	+12.9
	Inventories	177.2	182.5	+5.3
	Other	34.1	39.4	+5.3
Total Non-Current Assets		359.0	429.7	+70.7
	Property, Plant and Equipment	256.1	308.9	+52.8
	Intangible Fixed Assets	11.2	10.8	-0.4
	Investments and Other Assets	91.7	110.0	+18.3
Total Assets		765.6	839.2	+73.6
Liabilities		455.2	464.3	+9.1
	Interest-bearing Liabilities	322.0	304.1	-17.9
	Other	133.2	160.2	+27.0
Total Net Assets		310.4	374.9	+64.4
Total Liabilities and Net Assets		765.6	839.2	+73.6

Cash Flow Statement



(Unit : Billion Yen)

		2023/3	2024/3	Change
	Cash Flows from Operating Activities	26.8	76.7	+49.9
	Cash Flows from Investing Activities	-44.1	-55.4	-11.3
Free Cash Flows		-17.2	21.4	+38.6
Cash Flows from Financing Activities		20.0	-52.4	-72.3
Other		2.8	5.9	+3.1
Net Increase (Decrease) in Cash and Cash Equivalents		5.5	-25.1	-30.6
Cash and Cash Equivalents at End of Period		93.5	68.4	-25.1

Trend in Net Sales, Operating Income, and EPS



● Methanol(Asian spot price) (USD / ton)

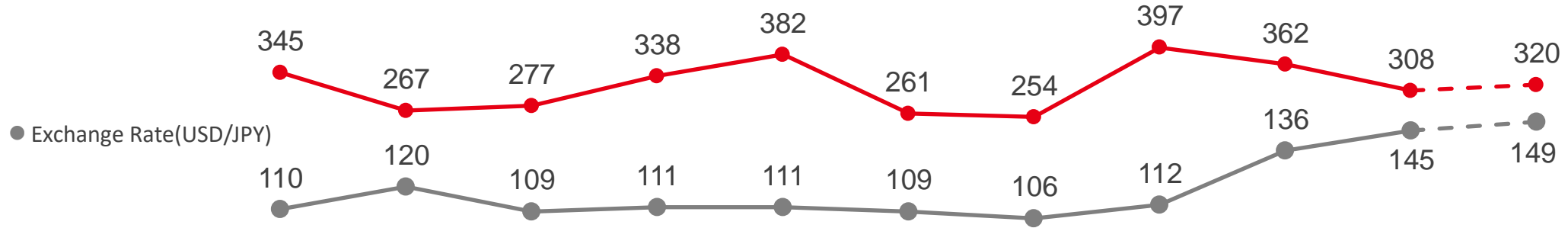

■ Net Sales (billion yen)

□ Operating Income (billion yen)

◆ EPS (yen)

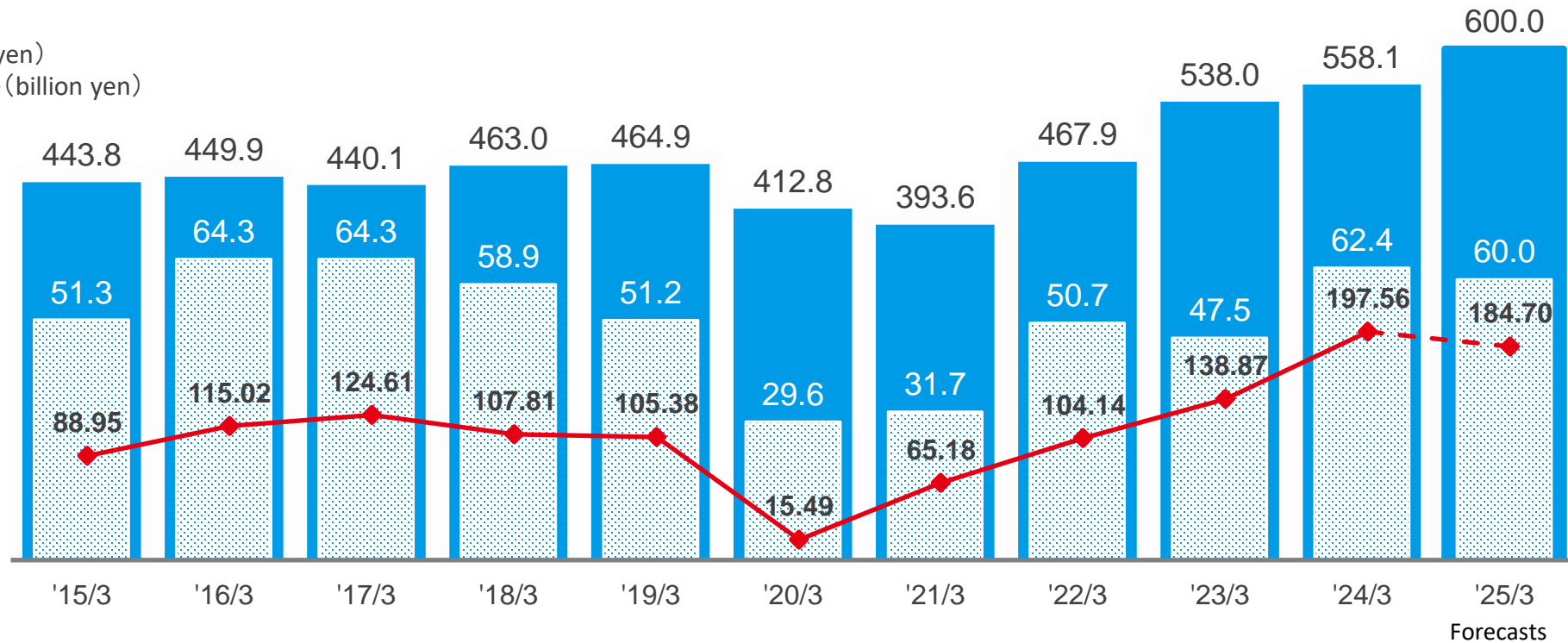

This forecast is announced on Nov. 7, 2024.

Net Sales and Operating Income by Segment (FY24/3 Results, YoY comparison)



Unit : Billion Yen

	Net Sales			
	2023/3 Results	2024/3 Results	Y on Y	
			Change	%
Medical / Healthcare	16.6	13.9	-2.7	-16.0%
Smart	29.6	30.7	+1.1	+3.8%
Safety	84.0	95.6	+11.6	+13.8%
Materials	160.8	185.3	+24.6	+15.3%
Engineering Plastics	238.1	226.8	-11.2	-4.7%
Others	9.1	5.7	-3.4	-37.3%
Total	538.0	558.1	+20.0	+3.7%

Unit : Billion Yen

	Operating Income			
	2023/3 Results	2024/3 Results	Y on Y	
			Change	%
Medical / Healthcare	1.3	0.8	-0.5	-37.2%
Smart	-0.6	-2.9	-2.2	-
Safety	0.5	3.0	+2.5	+478.5%
Materials	20.7	42.7	+22.0	+106.3%
Engineering Plastics	25.3	18.3	-7.0	-27.7%
Others	0.3	0.4	+0.1	+21.6%
Total	47.5	62.4	+14.9	+31.3%

EBITDA	
2023/3 Results	2024/3 Results
2.9	2.0
2.1	0.1
7.1	10.3
32.0	56.0
34.0	26.7
0.9	1.0
79.1	96.1

(Note) The above segment for FY2023/3 is the figure after segment changing in the Cosmetics Raw Material 1,3-BG and Novel Drug Delivery Devices R&D functions.

Net Sales and Operating Income by Segment (FY25/3 Forecast, YoY comparison)

Unit : Billion Yen

	Net Sales			
	24/3 Results	25/3 forecasts	Y on Y	
			Change	%
Medical / Healthcare	13.9	15.0	+1.1	+7.7%
Smart	33.8	38.0	+4.2	+12.4%
Safety	95.6	100.0	+4.4	+4.6%
Materials	182.2	191.0	+8.8	+4.8%
Engineering Plastics	226.8	250.0	+23.2	+10.2%
Others	5.7	6.0	+0.3	+5.7%
Total	558.1	600.0	+41.9	+7.5%

Unit : Billion Yen

	Operating Income			
	24/3 Results	25/3 forecasts	Y on Y	
			Change	%
Medical / Healthcare	0.8	0.7	-0.1	-11.5%
Smart	-0.9	-0.3	+0.6	-
Safety	3.0	5.2	+2.2	+73.9%
Materials	40.8	29.5	-11.3	-27.7%
Engineering Plastics	18.3	24.0	+5.7	+31.1%
Others	0.4	0.9	+0.5	+113.3%
Total	62.4	60.0	-2.4	-3.8%

EBITDA	
24/3 Results	25/3 forecasts
1.8	1.7
2.5	2.7
15.3	12.8
51.7	48.7
34.9	35.2
1.3	1.4
107.5	102.5

(Note) Net sales and operating income by segment for FY2024/3 is the figure after segment changing in the TAC, Cycloaliphatic Epoxies and Caprolactone Derivatives. And this forecast is announced on Nov. 7, 2024.

Unit : Billion Yen

	21/3 Results	22/3 Results	23/3 Results *1	23/3 Results *1, 2	24/3 Results *1	24/3 Results *1, 3	25/3 Forecasts *1,4
Medical / Healthcare	2.1	1.9	2.2	2.8	2.4	2.4	2.7
Smart	2.7	3.6	4.2	4.2	4.0	4.8	4.9
Safety	5.1	5.6	6.3	5.7	6.0	6.0	7.0
Materials	1.6	1.5	2.8	2.8	3.8	3.1	3.5
Engineering Plastics	3.5	3.7	6.1	6.1	6.8	6.8	7.6
Others / Corporate	4.6	4.5	0.3	0.3	0.3	0.3	0.3
Total	19.5	20.7	21.9	21.9	23.4	23.4	26.0

*1 Reflects the revised method of allocating corporate expenses. Figures for "Others/Corporate" are only for "Other Businesses."

*2 Reflects segment changes effective April 1, 2023 in the Cosmetics Raw Material 1,3-BG and Novel Drug Delivery Devices R&D functions.

*3 Reflects segment changes effective April 1, 2024 in the TAC, Cycloaliphatic Epoxies and Caprolactone Derivatives.

*4 This forecast is announced on Nov. 7, 2024.

Capital Expenditures

Unit : Billion Yen	21/3 Results	22/3 Results	23/3 Results *1	23/3 Results *1, 2	24/3 Results *1	24/3 Results *1, 3	25/3 Forecasts *1,4
Medical / Healthcare	8.7	1.0	2.7	2.2	1.9	1.9	1.0
Smart	2.0	2.9	4.2	4.2	2.6	3.0	3.0
Safety	8.8	7.7	9.0	9.0	9.4	9.4	14.0
Materials	11.6	18.8	8.6	9.1	17.4	16.9	10.0
Engineering Plastics	7.1	7.4	30.6	30.6	45.7	45.7	47.0
Others / Corporate	1.4	3.0	1.2	1.2	0.4	0.4	1.0
Total	39.6	40.8	56.3	56.3	77.5	77.5	76.0

*1 Reflects the revised method of allocating corporate expenses. Figures for "Others/Corporate" are only for "Other Businesses."

*2 Reflects segment changes effective April 1, 2023 in the Cosmetics Raw Material 1,3-BG and Novel Drug Delivery Devices R&D functions.

*3 Reflects segment changes effective April 1, 2024 in the TAC, Cycloaliphatic Epoxies and Caprolactone Derivatives.

*4 This forecast is announced on Nov. 7, 2024.

Depreciation and Amortization



Unit : Billion Yen	21/3 Results	22/3 Results	23/3 Results *1	23/3 Results *1, 2	24/3 Results *1	24/3 Results *1, 3	25/3 Forecasts *1,4
Medical / Healthcare	1.4	1.4	2.8	1.5	1.1	1.1	1.0
Smart	1.6	2.0	2.7	2.7	2.9	3.1	3.0
Safety	4.7	5.0	6.5	6.5	7.1	7.1	7.5
Materials	9.0	9.0	9.7	11.0	13.1	12.9	19.0
Engineering Plastics	6.9	7.0	8.6	8.6	8.2	8.2	11.0
Others / Corporate	2.2	2.5	0.6	0.6	0.6	0.6	0.5
Total	25.8	26.9	30.8	30.8	33.0	33.0	42.0

*1 Reflects the revised method of allocating corporate expenses. Figures for "Others/Corporate" are only for "Other Businesses."

*2 Reflects segment changes effective April 1, 2023 in the Cosmetics Raw Material 1,3-BG and Novel Drug Delivery Devices R&D functions.

*3 Reflects segment changes effective April 1, 2024 in the TAC, Cycloaliphatic Epoxies and Caprolactone Derivatives.

*4 This forecast is announced on Nov. 7, 2024.

Medical/Healthcare Business

[Life Science Business]

Chiral-related Business (Chiral Column, etc.)

Chiral Column
No. 1 Global
Market Share

◇ Product Characteristics

- A chiral column is a column that separates optical isomers*.
- It is used in research and manufacturing of drugs to separate ingredients that cause side effects from those that are effective as drugs.

*Optical isomers: Also called enantiomers, these are isomers that have the same molecular structure, but the atomic arrangement in the molecule is symmetrical, like the left and right palms.

◇ Business Characteristics

- More than 40 years of experience in the global pharmaceutical market (drug discovery and generics)
- Global customer base of companies, universities, and research institutes
- Providing solutions with a wide range of products through continuous product development
- Product sales, technical services and separation services in 5 locations around the world (Japan, China, India, France, and the United States)
- Maintain market share in the mature markets of Japan, Europe, and the United States, while continuing high growth in the growing markets of China and India.
- Also, focus on the growing field of medium molecule pharmaceutical-related services in India.

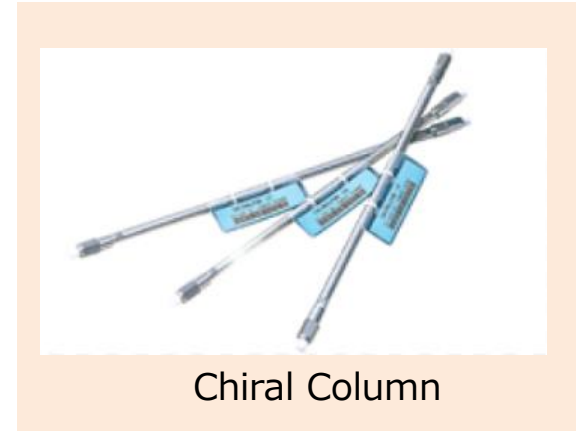

Medical/Healthcare Business

[Life Science Business]

Actranza[®] Lab (For Animal Testing)

◇ Product and Business Features

- This device uses gas generation as a driving force to deliver a drug solution into a specific tissue without using a needle. (Utilization of One Time Energy[®] based on inflator production technology for automobile airbags)
- Actranza[®] Lab for animal testing launched in Japan, the United States and Europe in mid-June 2022.

➤ Three points of Actranza[®] Lab

1. High-speed jet injection without a needle
2. Depth control to deliver the drug to the target (Precise pressure control cultivated through advanced production technology)
3. Easy one-handed operation

◇ Accelerated commercialization

- Daicel Medical was established in October 2023, and a strategic capital alliance with PharmaJet, which is engaged in the needle-free syringe business in the United States.
- Daicel Medical obtained the second-class medical device manufacturing and sales license in April 2024, and Daicel Harima Plant obtained the medical device manufacturing license in October 2024.
- Under Daicel Medical, Daicel and PharmaJet will work together to accelerate medical device approval for devices and to foster the needle-free syringe market in Japan and overseas.

DAICEL



Actranza[®] Lab For Animal Testing

Medical/Healthcare Business

[Healthcare Business]

BELLOCEA® (cellulose acetate spherical particles)

◇ Product and Business Features

- Cellulose acetate is processed into spherical particles
- Marine biodegradable and expected to contribute to solving marine plastic problems in the cosmetics industry
- The European Regulation (OECD301 F certification) compliant grade will be launched in the fiscal year ending March 2025
- In Europe, a ban on cosmetics using microplastic beads was announced in 2023, and the use of alternatives from major manufacturers increased.

◇ Application

As a cosmetic touch improver, foundation, sunscreen, etc.

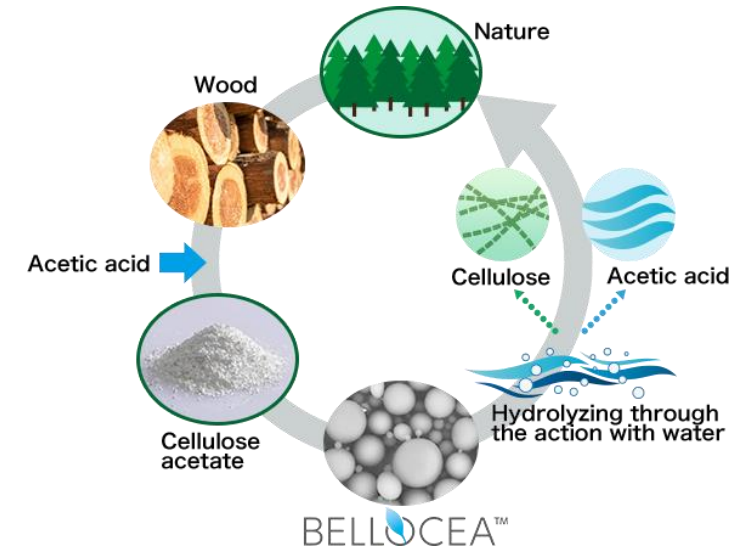

Functional food material

◇ Product and Business Features

- Our main product is equol (intestinal metabolites), which utilizes our unique anaerobic fermentation technology
- A unique material derived from extraction technology (Konjac ceramide)
- Expanded product lineup of intestinal metabolites, including equol, pomegranate-derived URORICH®, and hop-derived Astrohop™.
- Strengthening evidence-based on the results of human clinical trials of the product's functions, such as improving brain function of konjac ceramide and functionality of Astrohop™ in relation to muscle function.



Smart Business

[Functional Products Business]

Cycloaliphatic epoxies

No. 1 global market share

◇ Product and Business Features

- Main Ingredient: Peracetic acid (manufactured in-house)
- The only supplier in Japan
- Heat resistant and used to "harden" objects
- The world's only manufacturing method using peracetic acid does not contain chlorine in the manufacturing process and impurities are low
=>Boasting a high share in heavy electric (insulating) and electrical materials applications that require durability and reliability
- High heat resistance, low viscosity and excellent workability compared to competing materials
- Extensive lineup of special epoxies with high added value utilizing molecular design and analysis technologies accumulated over 40 years
- Global technical support based on customer needs

◇ Main applications

General applications: UV coating, coil insulation varnish, lubricating oil and other additives

Growth applications: OLED display encapsulants, EV motor insulators, CFRP (carbon fiber Reinforced Plastics)
Protective materials for power module components, etc.
In addition to epoxy, we will also sell premixed materials for new markets such as EVs.

◇ Manufacturing base

Ohtake Plant in Hiroshima Prefecture

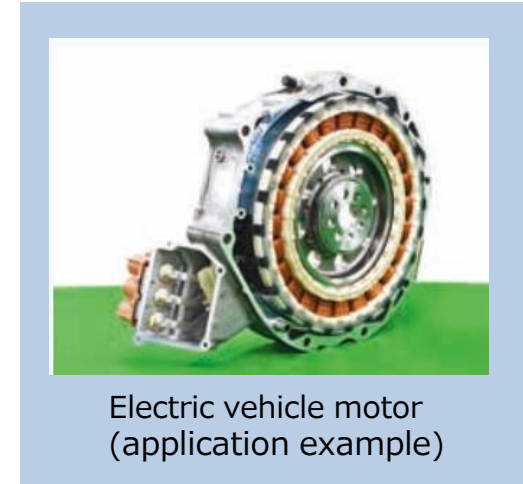

Electric vehicle motor (application example)

Smart Business

[Functional Products Business]

Caprolactone derivatives

◇ Product and Business Features

- Main ingredient: Peracetic acid (manufactured in-house)
- Top class global market share
- The only supplier in Japan
- We have a lineup of various grades to suit a wide range of applications
- Heat resistance, abrasion resistance, low viscosity and excellent workability
- We have strong sales channels in the urethane industry in Asia.
We develop and sell new applications by accurately understanding the needs of end users and markets.

◇ Main applications

General applications: Urethane (Shoe soles, artificial leather, automotive and architectural paints, automotive interior materials, transparent sealants)

Growth applications: Paint protection film, PU pad, etc.

◇ Manufacturing base

Ohtake Plant in Hiroshima Prefecture



[Functional Products Business]

Optical lens

◇ Product and Business Features

- Main ingredient: Heat/UV-curable resin (epoxy)
- Applicable to semiconductor mounting processes with high heat resistance
- Can produce thin and small products that cannot be achieved by injection molding
- Mass production is possible with one molding (approx. 2,000 pieces/time). Dicing is also possible after laminating wafers

◇ Main applications

For 3D sensing, face/iris authentication, VR goggles (for eye tracking), motion sensing

◇ Manufacturing base

Harima Plant in Hyogo Prefecture

◇ Molding Process

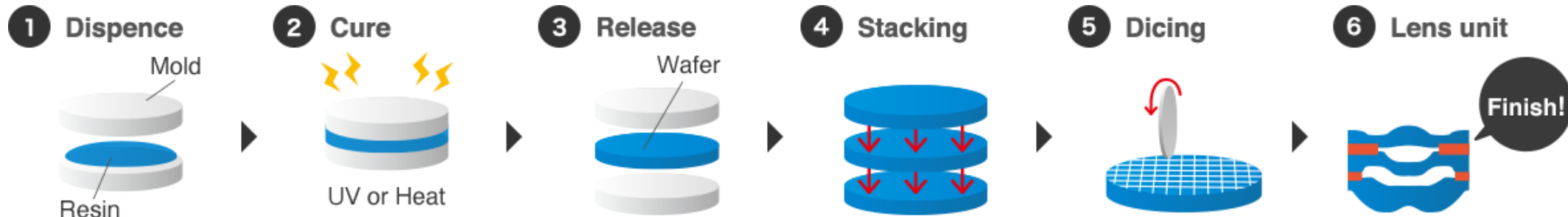

[Advanced Technology Business]

Polymers for photoresists

◇ Product and Business Features

- Design and integrated production of resist polymers for immersion ArF and EUV from monomers
- Design and precision synthesis from chemical structures in-house
- Production and quality control using metal and foreign matter removal technology
- Global share of resist polymers for immersion ArF over 20%

◇ Main applications

Semiconductors (Main application is immersion ArF. EUV applications are also under joint development with customers.)

Liquid crystal displays (High heat resistance achieved through our company's peracetic acid epoxidation technology.)

◇ Manufacturing sites

Arai Plant in Nigata Prefecture

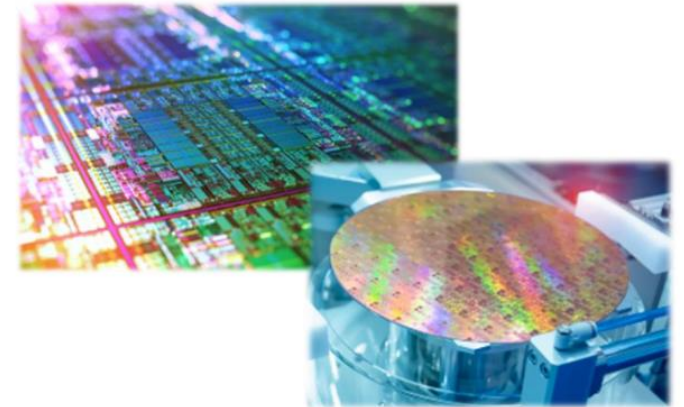

[Advanced Technology Business]

Solvents for Electronic Materials(PGME, PGMEA, MBA)

◇ Product and Business Features

- The only integrated production of PGME and PGMEA in Japan
- The company has a wide range of high-purity, low-metal solvents to meet the demands of semiconductor miniaturization, and a production and quality control system. PGMEA has a top-class share in the semiconductor photoresist industry in Japan

◇ Main Application

Photoresist and detergent for semiconductors and liquid crystal displays

◇ Manufacturing base

Ohtake Plant in Hiroshima Prefecture
(capacity expansion in July 2023)

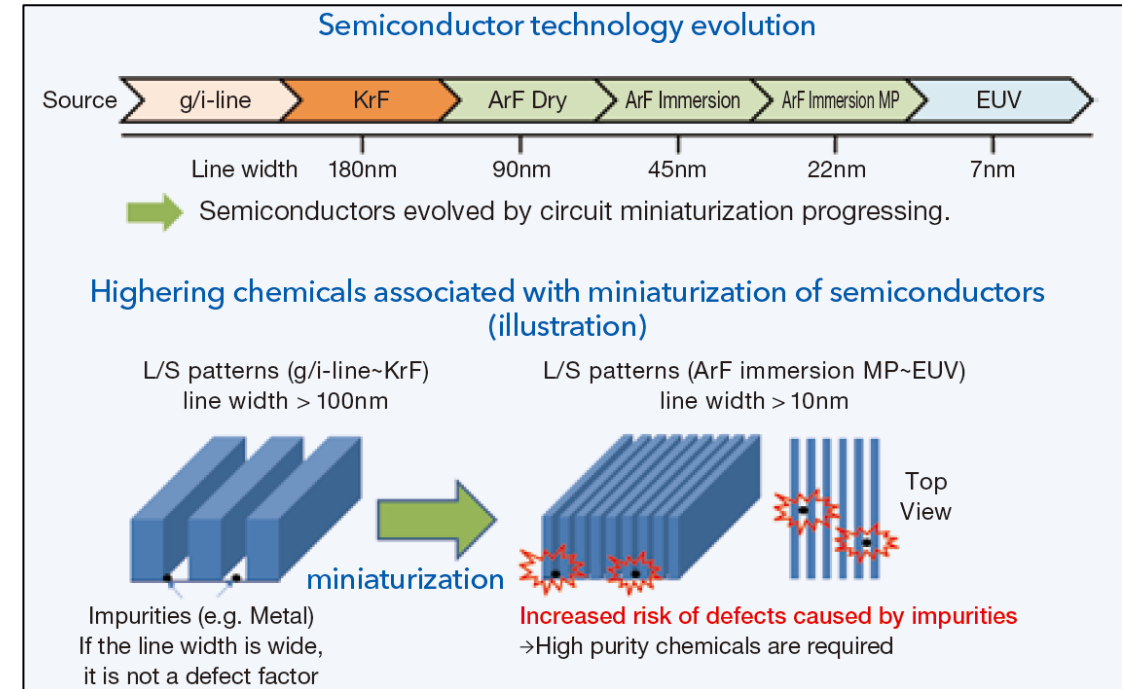

[Advanced Technology Business]

High-performance films

◇ Product and Business Features

- A business model in which base film (PET, etc.) is procured externally and functions are added by coating
- In FY2023/3, we acquired dry coating technology by acquiring the Gunze Kameoka Plant (currently Daicel Betond), an outsourcing company
- The world's only wet coating method achieves surface fine unevenness control technology
- Battery films (release films) have a very high global market share
- We also offer a wide variety of high-performance films products, including low reflection, fingerprint resistance, and high antibacterial and viral performance

◇ Main applications

Automotive displays, Battery films, TV and PC displays, pen input displays, etc.

◇ Manufacturing sites

Kameoka Plant in Kyoto prefecture (Daicel Beyond)

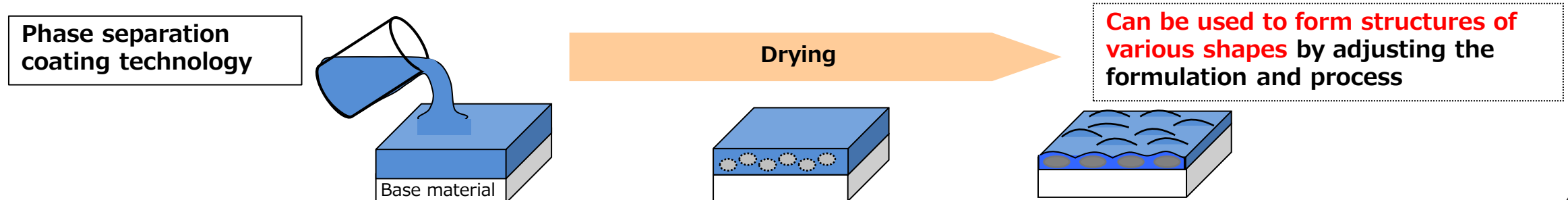

Safety Business

[Mobility Business]

Inflator for automotive airbags



◇ Product and Business Features

- Since commercialization of inflators in 1988, integrated production from the main components, initiators and gas generators
- A manufacturer specializing in inflators for automotive airbags Targeting a 25% global market share by FY2026/3 by steadily capturing growing demand in emerging countries
- Focusing on Japanese automakers, the company actively develops non-Japanese automakers, such as fast-growing Chinese automakers.
- Pursuing high quality and productivity by applying DAICEL Production Innovation Production System based on Toyota Production System.

◇ Manufacturing sites

- Japan (Hyogo Prefecture), China, North America (Arizona), Poland, Thailand, India
- As production sites were consolidated and closed, the South Korean site was closed in 2022, and production at the North American Kentucky site was terminated in 2023. Meanwhile, a new manufacturing site began commercial operation in India in October 2023, where further market growth is expected.

◇ Structure (Left: Pyro, Right: Hybrid)

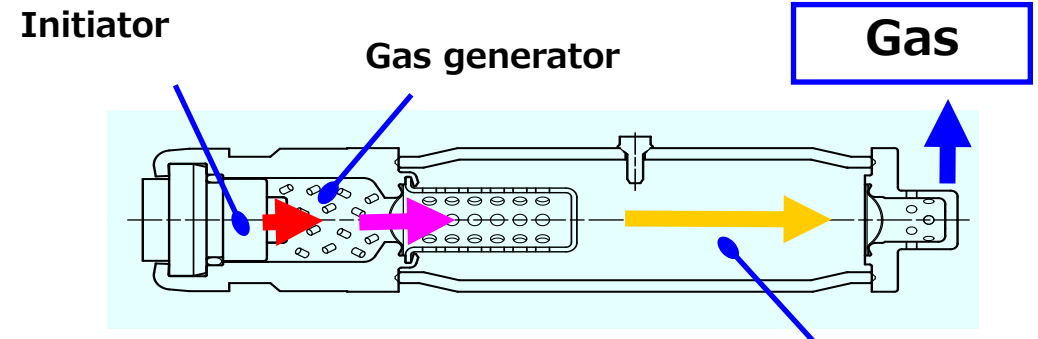
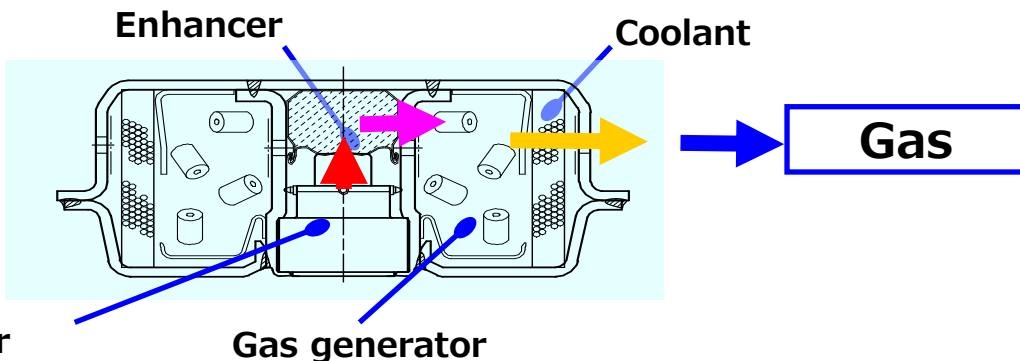

Safety Business

[Industry Business]

Pyro-Fuse

◇ Product and Business Features

- In the event of an emergency, high-voltage current is immediately and reliably blocked by pyrotechnic technology. (Higher reliability than relays and fuses)
- Mass production started at the European base in FY 2025/3

◇ Main applications

- Automotive applications such as EVs
- Industrial storage systems, large battery systems, renewable energy storage and transmission systems, etc.

◇ Operating principle

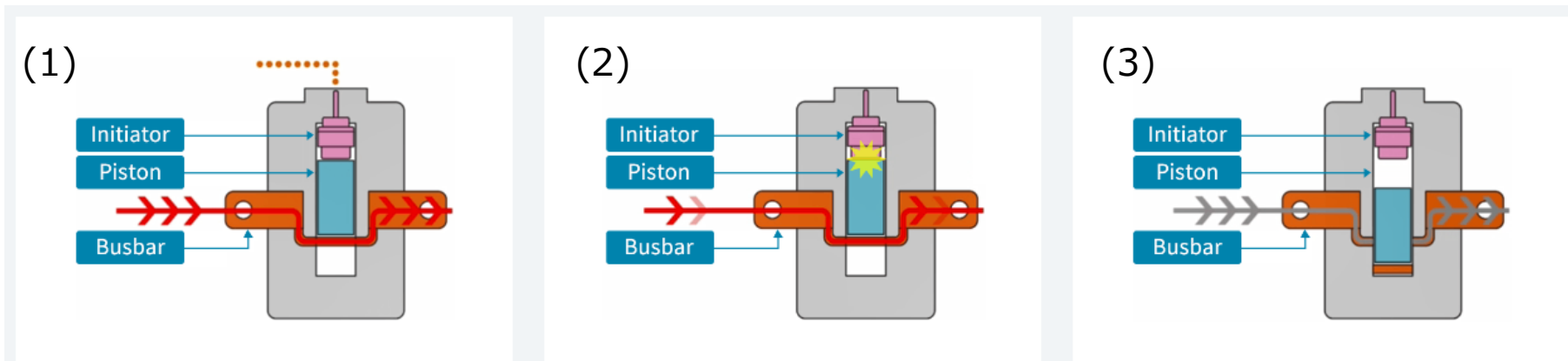

- (1) The ignition current is generated based on the ECU signal.
- (2) The initiator ignition operates gas emission.
- (3) The pressurized piston detaches the busbar, shutting down the electric circuit.

Materials Business

[Acetyl Business]

Acetic acid

◇ Product and Business Features

- Manufacturing Process: Methanol Process (Reaction between methanol and carbon monoxide)
- The only manufacture in Japan
- Carbon monoxide manufacturing plant was renewed in February 2024. (Refurbished due to aging, switching raw materials from asphalt to coal)
- Half of the acetic acid produced is consumed in-house as raw materials such as cellulose acetate and ester solvents.
- Establishment of a recycling system to recover and reuse acetic acid produced by customers and our group Plant
- Core Products of our company Acetyl Chain (Figure below)

◇ Main use (external sales)

Vinyl acetate (VAM): For adhesives and Raw materials for PVOH/EVA/EVOH (for film, fiber and paper processing)

High-purity terephthalic acid (PTA) : PET bottles and polyester fibers

◇ Manufacturing site

Aboshi Plant in Hyogo Prefecture

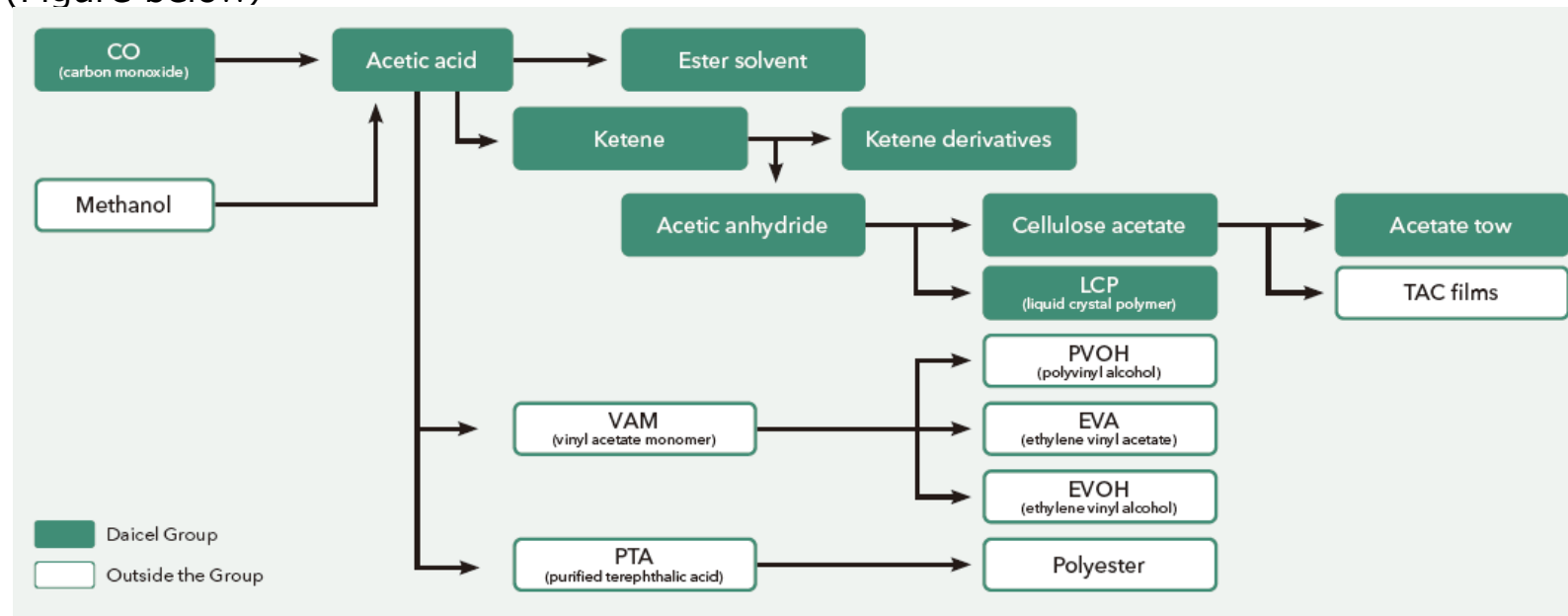

Materials Business

[Acetyl Business]

Acetate Tow

◇ Product and Business Features

- Main Ingredients: Cellulose Acetate (made in-house)
- Top class global market share (only supplier in Japan)
- Major tobacco manufacturers are our major customers.
Building long-term relationships of trust through high quality and stable supply
- Exports most of the production volume. Supply mainly to Asia, but also to Europe and the Middle East
- Due to the following background, the demand for filter tows has exceeded the demand for cigarettes
 - ✓ Filters have been introduced in areas where filters have not been used in the past.
 - ✓ Longer filters due to health concerns
 - ✓ Some of heated tobacco products, whose market expected to grow in the future, use acetate tow.

◇ Main Applications

Cigarette filters

◇ Production sites

Aboshi Plant (Hyogo Prefecture), Ohtake Plant (Hiroshima Prefecture), Toyama Filter Tow Co., Ltd. (Toyama Prefecture)



Materials Business

[Chemical Business]

Cellulose acetate

This page: cellulose diacetate (DAC, Di-acetyl cellulose) mainly used for fibers and plastics

Next page: cellulose triacetate (TAC, Tri-acetyl cellulose) mainly used for LCD optical films (TAC)

◇ Product and Business Features

- Main Raw Materials: Cellulose (derived from wood and cotton) and acetic anhydride (manufactured in-house)
- Consumption of most of the production volume as raw material for acetate tow
- Develops CAFBLO[®] resin that utilizes its characteristics as a biodegradable and biomass material.

◇ Main applications

DAC:(Private consumption) Acetate tow, (Outside sales)Plastics

TAC(Outside sales): TAC films and Fibers

◇ Manufacturing sites

Aboshi Plant in Hyogo Prefecture, Ohtake Plant in Hiroshima Prefecture

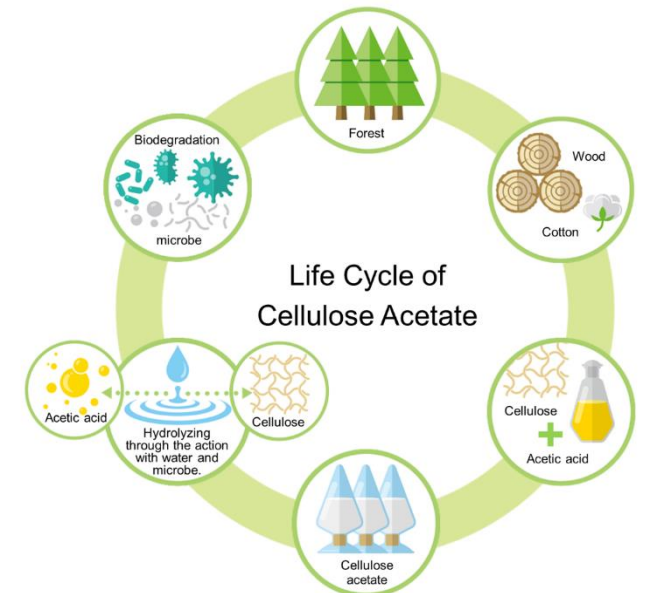

Materials Business

[Chemical Business]

Cellulose Acetate for LCD optical films (TAC)

◆ Features of TAC

- Main Ingredients: Cellulose (Wood pulp, cotton linters), Acetic anhydride (made in-house)
- Global market share: Top as a TAC supplier
- TAC film can be used as a protective film for liquid crystal displays and as a phase difference film. In the phase difference film, TAC is highly evaluated by panel manufacturers for the balance of functions such as optical properties and cost compared to films made from competing synthetic materials.
- Improvements in manufacturing methods further enhance the stability and competitiveness of quality and supply while expanding the range of use of natural raw materials with uneven quality

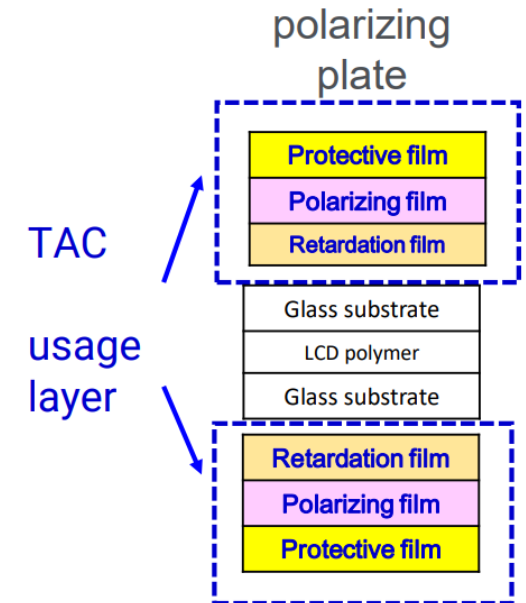

[Chemical Business]

1,3-BG (1,3 butylene glycol)

◇ Product and Business Features

- Our company products are characterized by high purity and almost no odor. Odor-free grades are highly evaluated in Asia, where strong fragrances are less preferred.
- Stable supply at two production sites, Ohtake Plant and Aboshi Plant
- The majority of cosmetics applications are in Japan, South Korea and China, but we are focusing on expanding our market share in China, Europe and America, where the cosmetics market is large, while maintaining our market share in the odorless market, where our company boasts its brand power.

◇ Main Applications

Cosmetics (Moisturizing and antibacterial functions),
Industrial (Urethane raw material, resin plasticizer, wood wetting agent)

◇ Manufacturing sites

Ohtake Plant in Hiroshima Prefecture, Aboshi Plant in Hyogo Prefecture
(New plant started operation at Aboshi plant in August 2022.)



Engineering Plastics Business

A wide portfolio to maximize our ability to provide engineering plastics with various functions such as high heat resistance

- Sharing Group companies' product portfolio and infrastructure
- We will expand our portfolio by forming alliance or joint venture

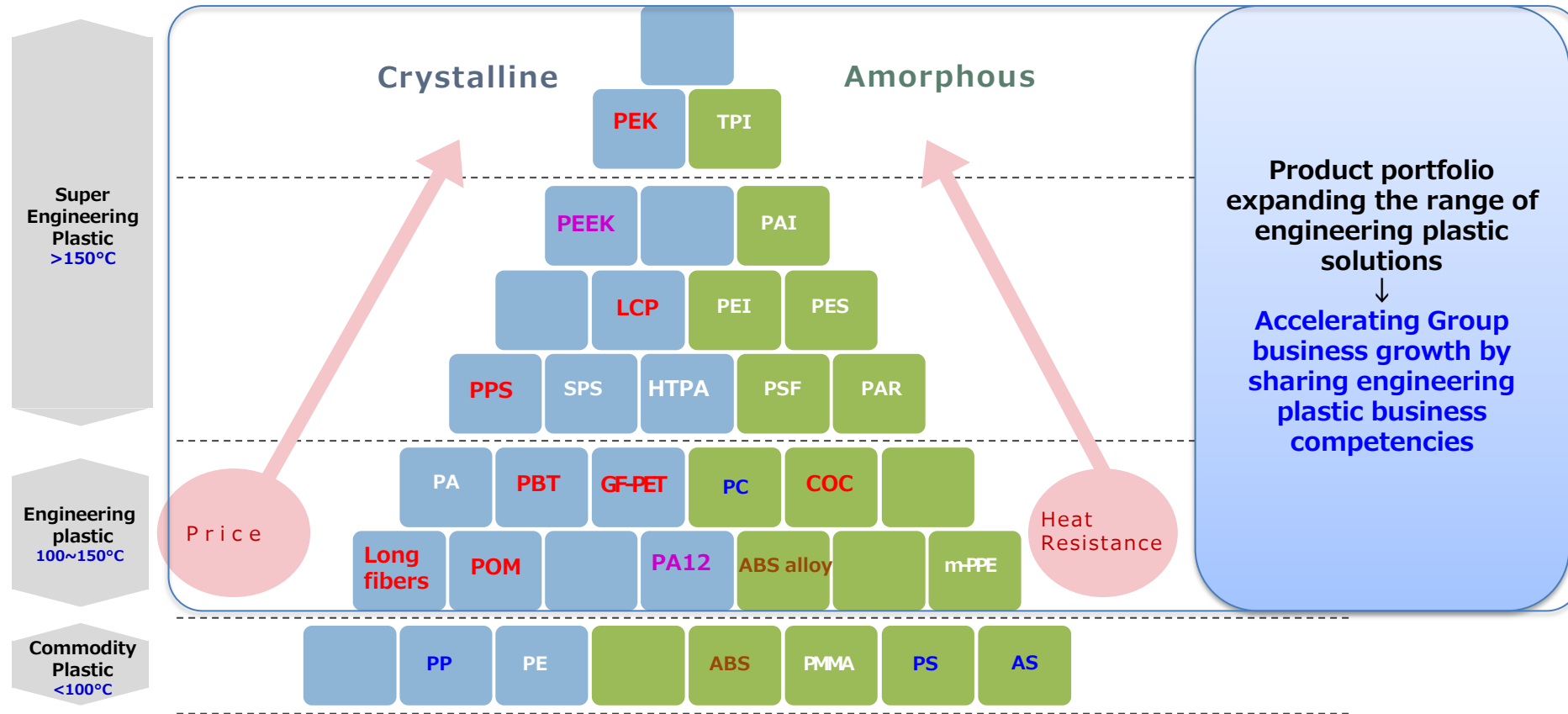

PPC products PEV products DMZ products Novacel Products

<Consolidated Subsidiaries> PPC: Polyplastics (100% subsidiary of Daicel), DMZ:Daicel Mirise (100% subsidiary of DC)
< Equity method affiliate > PEV: Polyplastics Evonic (Evonik 50%, PPC50%) , Novacel: DC 33.3% investment,

Engineering Plastics Business

[Polyplastics Co., Ltd.]

◇ Product and Business Features

- Over half a century of knowledge, experience and track record of developing applications that meet the needs of the times with customers as a specialized engineering plastic manufacturer
- Global cooperation at technical solution centers in six locations across Asia, Europe and the US enables integrated support from material formulation design to molding
- High market share in global market (POM, LCP)

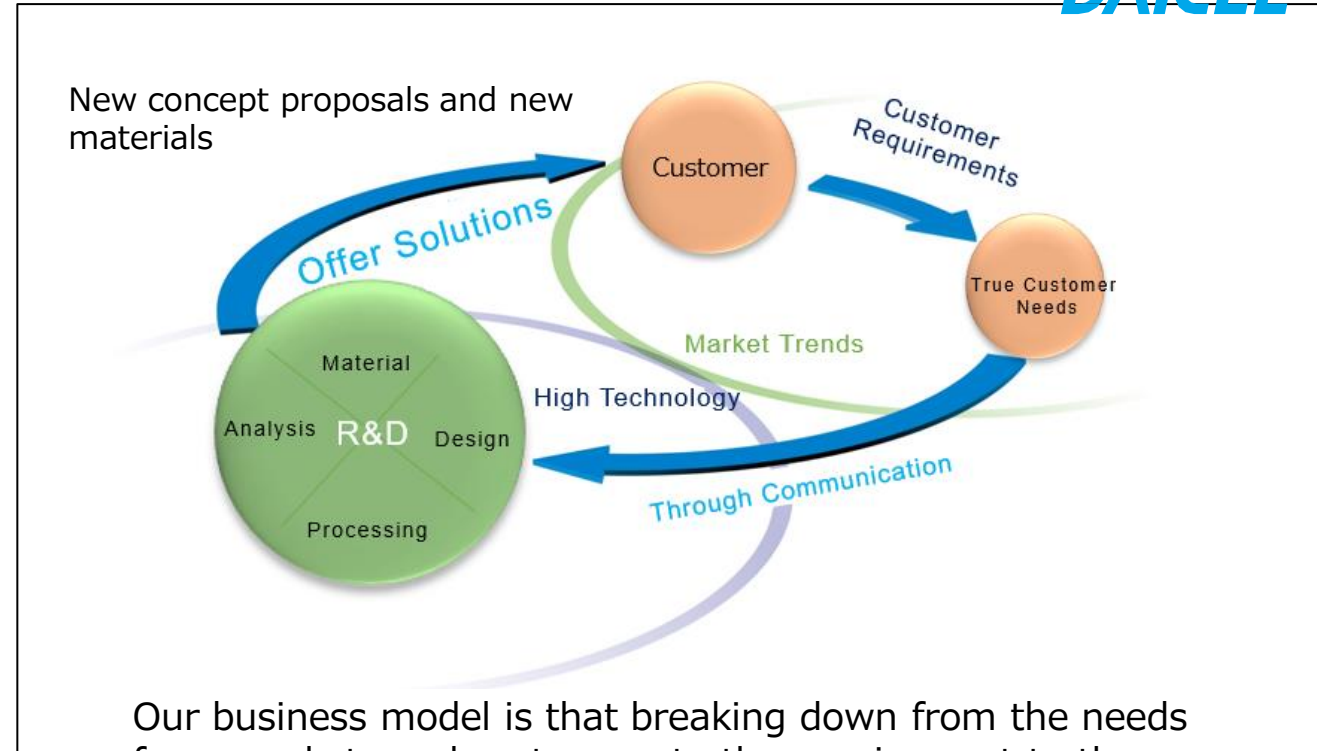

Our business model is that breaking down from the needs from markets and customers to the requirement to the Engineering Plastics, providing them with materials and instructions corresponded to the applications fulfilling customers' concept.

◇ Reference

May 1964 Establishment (Celanese 45%, Daicel 55%)
October 2020 Dissolution of joint venture with Celanese, and a 100% subsidiary of Daicel*

*A 100% subsidiary enables rapid decision-making, accelerating the expansion of markets in Europe and the United States, and synergies with Daicel

Engineering Plastics Business

[Polyplastics Co., Ltd.]

POM (Polyacetal)

◇Product Features

- Main Materials: Methanol
- Balanced Mechanical Properties, Excellent Sliding Properties, Friction and Wear Properties, Chemical Resistance (Oil, solvent), Spring Elasticity
- Development of new applications for EV (e.g., parts for BEVs* without heat source) and medical applications

*BEV (Battery Electric Vehicle): A vehicle that runs on electricity without using gasoline and is characterized by the lack of an engine. POM has low heat resistance, so it will be developed for use in BEV parts that do not have a heat source.

◇Main Applications

- Automotive applications
- Various industrial applications



Door lock



Fuel Pump Module



Combination Switch

Engineering Plastics Business

[Polyplastics Co., Ltd.]

PBT (polybutylene terephthalate)

◇ Product Features

- Main Ingredients: Terephthalic Acid, 1,4 Butadiol
- Excellent electrical properties, dimensional stability, and high heat resistance are used in electronic devices and electrical components
- Increased sales opportunities for ADAS (Advanced Driver Assistance System)/electrification in addition to conventional automotive connectors

◇ Main Applications

- Automotive applications
- Electrical/electronic applications
- Various industrial applications



Small switches



Terminal blocks*



Car-mounted sensors

*Terminal block: A part that acts as a relay to form an electrical circuit, such as between electric wires or between an electric wire and a printed circuit board.

Engineering Plastics Business

[Polyplastics Co., Ltd.]

Polyphenylene Sulfide (PPS)

◇Product Features

- Main Ingredients: Paradiclobenzene, Sodium Sulfide (PPS polymer is procured externally)
- Linear polymer achieves high toughness and impact resistance
- Heat resistance, heat shock resistance, and electrical properties (High volume resistivity, Low dielectric constant, etc.)
- Expanded use in core EV/HEV components such as PCUs*, motors, and cooling

* PCU (Power Control Unit): A power control unit developed to appropriately control the power of hybrid and electric vehicles that run on motors.

◇Main applications

- Automotive applications
- Various industrial applications
- Electrical/electronic applications



**IH Rice Cooker
Heater Coil Base**



HEV Motor Insulator



Electric VTC*

*VTC (Variable Timing Control): A system that controls the opening and closing timing of the intake/exhaust valves according to the engine's operating conditions.

Engineering Plastics Business

[Polyplastics Co., Ltd.]

LCP (Liquid Crystal Polymers)

◇Product Features

- Main Ingredients: p-HBA (para-hydroxybenzoic acid), acetic anhydride
- High thin-wall flowability (high flowability, wide range of molding conditions, and adaptable to various shapes)
- High heat resistance, high rigidity, and electrical properties (low dielectric constant, low dielectric loss tangent, etc.) compatible with SMT*.
- SMT connectors are increasingly used not only in 5G smartphones but also in EVs and servers.

◇Main applications

- Electrical/electronic applications
- Automotive applications

*SMT (Surface Mount Technology): A surface mounting technology used to mount electronic components on a circuit board. Solder is transferred to the board in advance, and after the electronic components are mounted, the board is heated and soldered.

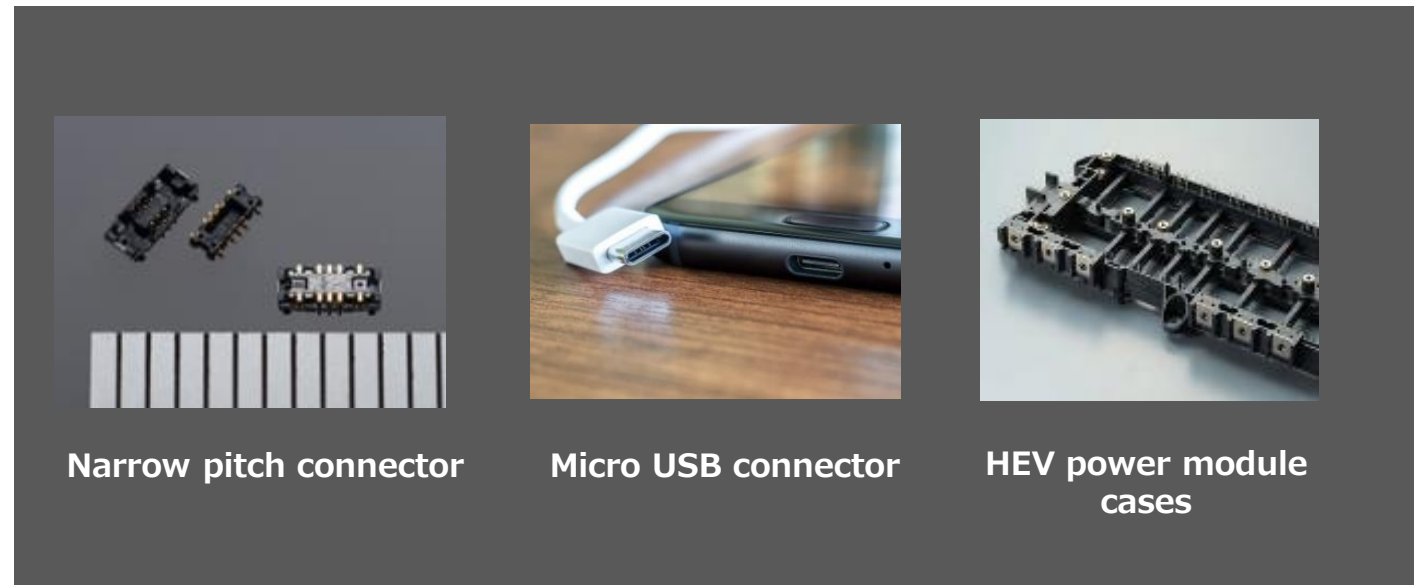

Narrow pitch connector

Micro USB connector

HEV power module cases

Engineering Plastics Business

[Polyplastics Co., Ltd.]

COC (cyclic olefin copolymer)

◇Product Features

- Main Ingredients: Norbornene, Ethylene
- Used for medical and food packaging with excellent transparency and high safety
- FDA registered with low adsorption, high heat resistance and water vapor barrier properties
- Label material for PET bottles that can be separated by floating in water for a recycling-oriented society

◇Main application

- Package application
- Medical applications



Prefilled syringes



Water quality test bottles



Freezer bags

Notes Regarding Forward-Looking Statements



- The purpose of this document is to provide information and not to persuade any individual to take any action in response to the information contained in this document.

Daicel has made the greatest possible effort to prepare this document with accurate information. The information in this document, however, may include risks or inaccuracy, and we do not guarantee the accuracy or reliability of this information.

- The reader is advised that the use of the information in this document is at your own risk.

Any investment according to the prospects, target values, etc. appearing in this document might result in a loss. Daicel accepts no responsibility for such an eventuality.

- All rights reserved by Daicel Corporation.
- This document shall not be copied or distributed to a third party without the permission of Daicel Corporation.